

Yealink | 亿联网络



W70B DECT IP Phone User Guide

Version: 85.40 | Date: Aug. 2022

Contents

Before You Begin.....	7
Related Documentation.....	7
Getting Started.....	7
Hardware Overview.....	7
W70B Base Station Hardware.....	8
W73H Hardware.....	9
W78H Hardware.....	10
W59R Hardware.....	12
W57R Hardware.....	13
W56H Hardware.....	15
W53H Hardware.....	16
CP930W Hardware.....	18
CP935W Hardware.....	20
DD Phone Hardware.....	21
WHM621/WHD622 with Charging Cable Hardware.....	23
WHM631 with Charging Cable Hardware.....	24
W73H/W78H/W56H/W53H/W59R/W57R Power LED Indicator.....	24
CP930W/CP935W Mute Touch Key LED Indicators.....	24
Menu on the W73H/W78H/W56H/W53H/W59R/W57R.....	25
Main Menu.....	25
Submenu.....	27
Returning to Idle Screen.....	28
Screen and Icons.....	28
Idle Screen.....	28
Calls Screen of CP930W.....	31
Calls Screen of CP935W.....	31
W73H/W78H/W56H/W53H/W59R/W57R Line Status Screen.....	32
Icons on the Idle Screen.....	32
W73H/W78H/W56H/W53H/W59R/W57R Icons on the Calls Screen.....	34
W73H/W78H/W56H/W53H/W59R/W57R Icons on the Line Status Screen.....	34
Rechargeable Battery.....	34
Viewing the Power Status.....	34
Power Saving Mode.....	35
Entering Characters.....	35
Setting the Input Modes.....	35
Entering Data on the W73H/W78H/W56H/W53H/W59R/W57R.....	36
Entering Data on the CP930W/DDPhone.....	36
Entering Data on the CP935W.....	37
Handset Registration.....	39
Putting the Base Station into the Registration Mode.....	39
Registering a New Handset to a Base Station.....	39
Registering a Handset to Another Base Station.....	40
Possible Reasons for Registration Failure.....	40
Selecting a Base Station to Connect.....	41
Renaming the Base Station.....	41

Deregistering a Handset.....	41
Headsets Registration.....	42
Switching Modes.....	42
Registering a New Headset to a Base Station.....	43
Pairing the Headset with a Handset.....	43
Using the Headset to Manage Calls.....	44
Call Features.....	44
Changing the Default Outgoing Line.....	45
Placing Calls.....	45
Placing Internal Calls.....	45
Placing External Calls.....	46
Placing a Call from the Call History.....	47
Placing a Call from the Directory.....	47
Placing a Call from the Shared Directory.....	47
Speed Dial on the W73H/W78H/W56H/W53H/W59R/W57R.....	48
Speed Dial on the DD Phone.....	49
Speed Dial on the Headset.....	49
Redial.....	49
Placing an Anonymous Call.....	51
Calling Emergency Alarm Number.....	51
Answering Calls.....	52
Assigning Incoming Lines to the Handset.....	52
Answering a Call.....	52
Answering a Call When in a Call.....	53
Answering a Call Automatically.....	53
Disabling Call Waiting.....	53
Switching Among the Receiver, Handsfree and Headset Modes.....	54
Silencing or Rejecting Incoming Calls.....	54
Silencing a Call.....	54
Rejecting a Call Manually.....	54
Rejecting Anonymous Calls.....	54
Rejecting Calls with Do Not Disturb (DND).....	55
Ending Calls.....	55
Muting/Unmuting Audio.....	55
Holding and Resuming Calls.....	55
Holding a Call.....	56
Resuming a Held Call.....	56
Call Forward.....	56
Forwarding Incoming Calls.....	56
Transferring Calls.....	57
Performing a Blind Transfer.....	57
Performing a Semi-Attended/Attended Transfer.....	57
Conference Calls.....	57
Local Conference.....	58
Hybrid UC Meeting.....	60
Network Conference.....	61
Recording Using an SD Card.....	63
Recording a Call.....	63
Pausing/Resuming a Recording.....	63
Stopping a Recording.....	64
Managing the Recordings.....	64
Viewing the Available Recording Time.....	65

Multicast Paging.....	65
Sending Multicast Paging.....	65
Receiving Multicast Paging.....	66
Managing a Paging Call.....	66
Advanced Call Features.....	66
Call Park and Call Retrieve.....	67
Parking or Retrieving a Call in the FAC Mode.....	67
Parking or Retrieving a Call in the Transfer Mode.....	68
Shared Call Appearance (SCA).....	68
W73H/W78H/W56H/W53H/W59R/W57R State Indicator of Shared Line.....	69
Placing Calls on a Shared Line.....	69
Answering Calls on a Shared Line.....	69
Placing a Call on Public Hold.....	69
Placing a Call on Private Hold.....	70
Retrieving a Held Call on a Shared Line.....	70
Barging in an Active Call on a Shared Line.....	70
Pulling a Shared Call on a Shared Line.....	70
Voice Mail.....	71
Setting the Voice Mail Code.....	71
Setting a Voice Mail Key for a Specific Line.....	71
Leaving Voice Mails.....	71
Listening to Voice Mails.....	72
Push-to-Talk (PTT).....	72
Initiating a PTT Meeting.....	72
Initiating a PTT Meeting on the Handset.....	73
Initiating a PTT Meeting on the Headset.....	73
Initiating a PTT Meeting on the DD Phone.....	74
Joining a PTT Meeting.....	74
Joining the PTT Meeting Without a Prompt.....	74
Joining the PTT Meeting With a Prompt.....	74
Exiting a PTT Meeting.....	75
Exiting a PTT Meeting on the Handset.....	76
Exiting a PTT Meeting on the Headset.....	76
Exiting a PTT Meeting on the DD Phone.....	76
Push-to-Talk.....	76
Listening to the Talk in Real Time.....	77
Directory.....	78
Local Directory.....	78
Adding Contacts.....	78
Viewing Contacts.....	78
Editing Contacts.....	79
Deleting Contacts.....	79
Searching for Contacts.....	80
Shared Directory.....	80
Adding Shared Contacts.....	80
Editing Shared Contacts.....	81
Deleting a Shared Contact.....	81
Deleting All Shared Contacts.....	81
Searching for Shared Directory Contacts.....	81
Saving a Shared Contact to the Local Directory.....	82

Blocklist.....	82
Adding a Blocklist Contact.....	82
Viewing Blocklist Contacts.....	83
Editing a Blocklist Contact.....	83
Deleting Blocklist Contacts.....	83
Remote Phone Book.....	84
Searching for Remote Phone Book Contacts.....	84
Viewing Remote Phone Book Contacts.....	84
Saving a Remote Phone Book Contact to the Local Directory.....	85
Updating Remote Phone Book.....	85
Call History.....	85
Call History Icons.....	85
Viewing History Records.....	86
Saving a History Record to Local Directory.....	87
Saving a History Record to Blocklist.....	87
Deleting History Records.....	87
Deleting a Call Record.....	87
Deleting All Call Records.....	88
Customizing Your Phone.....	88
Turning Handset On.....	88
Turning Handset Off.....	89
Changing the Base PIN.....	89
Changing the Wallpaper.....	90
Setting the Screen Saver.....	90
Changing the Brightness.....	90
Setting the Keypad Light.....	91
Changing the Language.....	91
Time & Date.....	91
Setting the Time and Date Manually.....	92
Changing the Time and Date Format.....	92
Shortcuts.....	92
Supported Shortcuts.....	92
Customizing the Shortcuts.....	93
Locking Your W73H/W78H/W56H/W53H/W59R/W57R.....	93
Locking Handset Keypad.....	94
Unlocking Your Handset.....	94
Locking Your DD Phone.....	94
Setting the Phone Lock.....	94
Locking Your Phone Manually.....	95
Unlocking Your Phone.....	95
Changing Your Phone Unlock PIN.....	95
Locating.....	95
Renaming the Handset.....	96
Setting the Eco Mode+.....	96
Setting the Eco Mode.....	96
Setting the Repeater Mode.....	97
Customizing the Soft Keys.....	97
Phone Mode.....	98
Audio Settings.....	98
Silent Mode.....	98

Switching on Silent Mode.....	98
Switching off Silent Mode.....	99
Adjusting the Volume.....	99
Setting the Ring Tone.....	99
Setting the Ring Tone for the Internal Calls.....	99
Setting the Ring Tone for the External Calls.....	99
Silent Charging.....	100
Setting the Advisory Tone.....	100
Setting the Vibrator.....	101
Disabling the Noise Cancellation.....	101

Connecting a Mobile Phone to your CP930W/CP935W via Bluetooth..... 101

Activating the Bluetooth Mode.....	102
Pairing and Connecting the Bluetooth-enabled Mobile Phone.....	102
Enabling the Phone Audio.....	102
Enabling the Phone Media.....	103
Handling a Mobile Phone Call on the Phone.....	103
Editing Device Name of Your Phone.....	104
Making the Phone Discoverable.....	104
Deleting the Paired Bluetooth Device.....	105
Disconnecting the Bluetooth Device.....	105
Deactivating the Bluetooth Mode.....	105

W59R/W57R/W78H Bluetooth..... 106

Enabling/Disabling the Bluetooth.....	106
Searching and Pairing with a Bluetooth Headset.....	106
Managing Paired Headsets.....	106
Editing Device Name of Your Handset.....	107

Using Your CP930W/CP935W with PC..... 107

Connecting the PC to the Phone.....	107
Setting the Phone as PC Audio Device.....	108
Setting the Phone as PC Audio Device via Softphone.....	108
Setting the Phone as PC Audio Device via PC.....	109
Placing Calls via PC.....	109
Holding/Resuming the PC Audio.....	109
Muting/Unmuting the Microphone.....	110

Maintaining Your Phone..... 110

Investigating Warnings.....	110
Restarting the Base Station.....	110
Resetting the Base Station.....	111
Restarting the Handset.....	112
Resetting the Handset.....	112
Triggering the Auto Provisioning.....	112

Appendix..... 113

Appendix A- Menu Structure.....	113
Appendix B - Input Modes and Characters.....	119

Before You Begin

This guide provides information you need to quickly use your new phone.

Firstly, verify with your system administrator that the IP network is ready for phone configuration. Also, be sure to read the Quick Start Guide which can be found in your phone package before you set up and use the phone. As you read this guide, keep in mind that some features are only configurable by your system administrator or determined by your phone environment. As a result, some features may not be enabled or may be operated differently on your phone. Additionally, the examples and graphics in this guide may not directly reflect what is displayed or is available on your phone screen.



Note: This guide mainly takes W73H as an example. Due to different LCD specifications and parameters, the graphics displayed on other handsets may be different.

- [Related Documentation](#)

Related Documentation

You can view more types of documents to make the phone to perform more functions.

The following types of related documents are available on each support page on Yealink support page:

- Quick Start Guide, which describes how to assemble your phone and configure the basic phone features.
- Administrator Guide, which provides detailed information on how to configure phone features for the system administrator.

You can also view other user documents which provide descriptions and examples for phone settings and features on the [Yealink support](#) page.

Getting Started

Before you use your phone, take some time to get familiar with its features and user interface.

The terms "the phone" and "your phone" refer to any of the IP phones. Unless specifically noted in this guide, all phone models are operated in similar ways.

- [Hardware Overview](#)
- [Menu on the W73H/W78H/W56H/W53H/W59R/W57R](#)
- [Screen and Icons](#)
- [Rechargeable Battery](#)
- [Entering Characters](#)

Hardware Overview

Understanding the phone hardware helps you easily use the phone's features.

- [W70B Base Station Hardware](#)
- [W73H Hardware](#)
- [W78H Hardware](#)
- [W59R Hardware](#)
- [W57R Hardware](#)

- W56H Hardware
- W53H Hardware
- CP930W Hardware
- CP935W Hardware
- DD Phone Hardware
- WHM621/WHM622 with Charging Cable Hardware
- WHM631 with Charging Cable Hardware
- W73H/W78H/W56H/W53H/W59R/W57R Power LED Indicator
- CP930W/CP935W Mute Touch Key LED Indicators

W70B Base Station Hardware

After the base station starts up successfully and the handset is registered to the base station, all LEDs on the base station glow green.

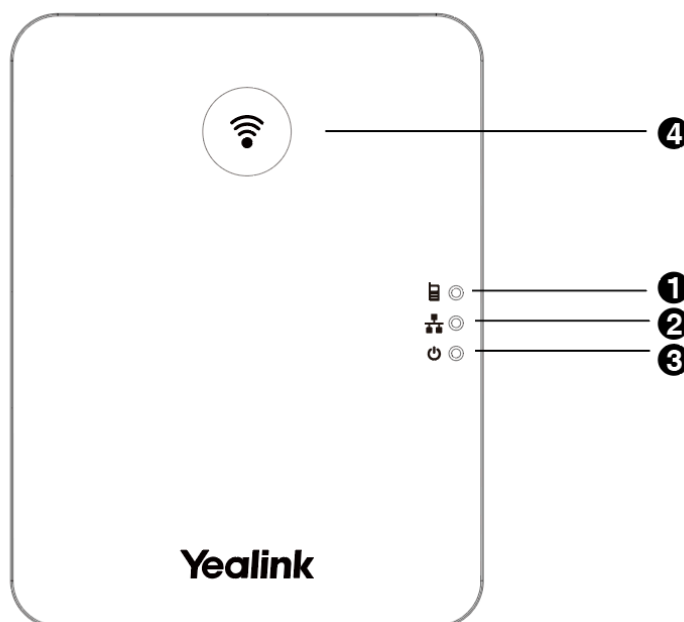

No.	Item	Description
1	Registration LED	Indicates the handset registration status or the base station is in the paging mode.
2	Network Status LED	Indicates the network status.
3	Power LED Indicator	Indicates the power status of the base station.
4	Paging Key	<ul style="list-style-type: none"> • Locates a misplaced handset. • Toggles the registration mode. • Resets the base station to factory settings.

W73H Hardware

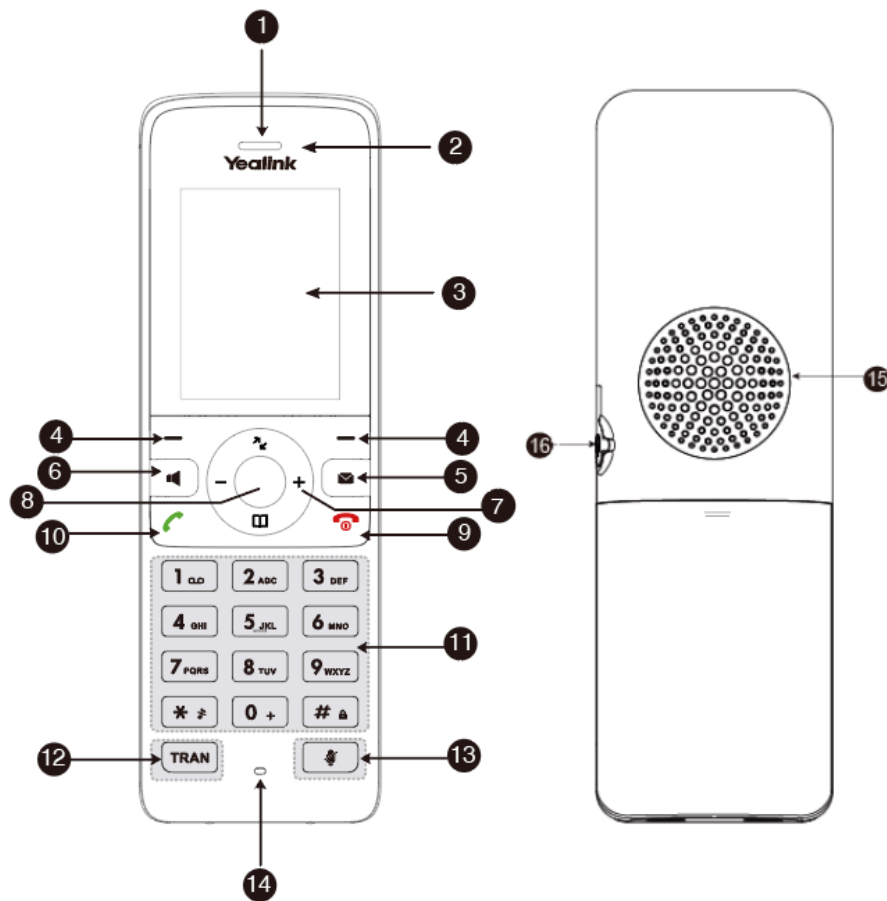

No.	Item	Description
1	Receiver	Receives audio in receiver mode.
2	Power LED Indicator	Indicates call status, message status, and charging status.
3	Phone Screen	Shows information.
4	Soft Keys	Access the function directly. It depends on the operating situation.
5	Message Key	Accesses the voice mail or missed call.
6	Speakerphone Key	<ul style="list-style-type: none"> Switches among the receiver, headset, and handsfree modes. Answers an incoming call. Places a call in handsfree mode.
7	Navigation Keys	Scroll through information or options on the screen.
8	OK Key	Confirms actions or enters the main menu.

No.	Item	Description
9	On-hook Key/Power Key	<ul style="list-style-type: none"> Press briefly to return to the previous screen. Long press to return to the idle screen. Press to turn the handset on. Long press on the idle screen to turn the handset off. Cancels actions or ends a call. Rejects an incoming call.
10	Off-hook Key	<ul style="list-style-type: none"> Answers an incoming call. Enters the redial calls list. Places a call in receiver or headset mode.
11	Keypad	Provides digits, letters, and special characters.
12	TRAN Key	Transfers a call to another party.
13	Mute Key	Toggles mute feature on or off.
14	Microphone	Picks up audio.
15	Speaker	Outputs audio in handsfree mode.
16	3.5 mm Headset Jack	Connects a standard 3.5 mm headset.

W78H Hardware

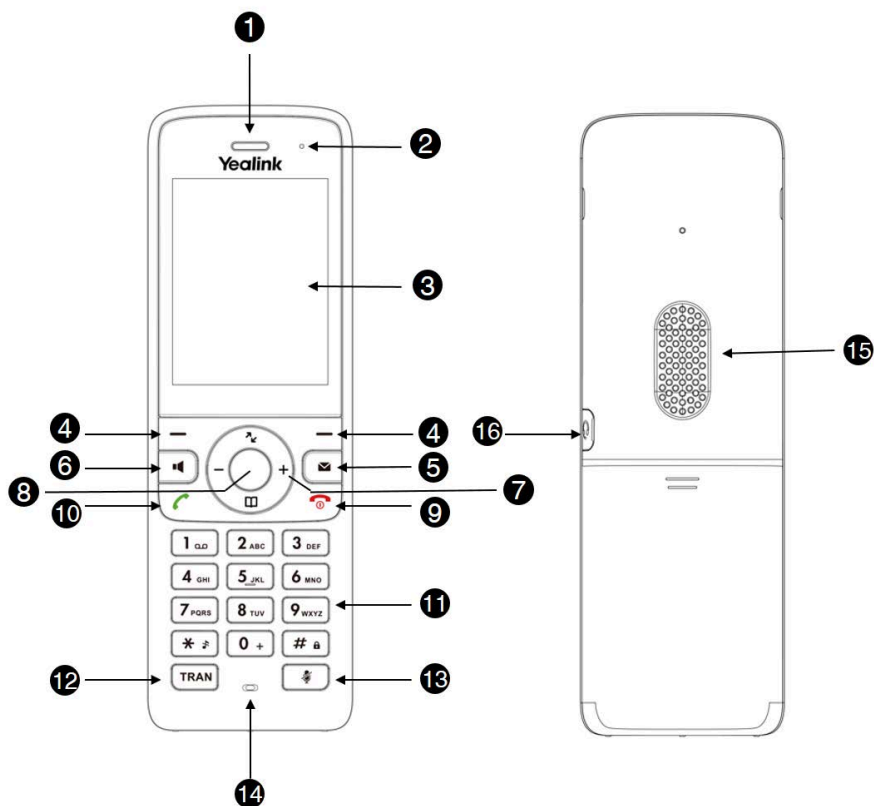

No.	Item	Description
1	Receiver	Receives audio in receiver mode.
2	Power LED Indicator	Indicates call status, message status, and charging status.
3	Phone Screen	Shows information.
4	Soft Keys	Access the function directly. It depends on the operating situation.
5	Message Key	Accesses the voice mail or missed call.
6	Speakerphone Key	<ul style="list-style-type: none"> • Switches among the receiver, headset, and handsfree modes. • Answers an incoming call. • Places a call in handsfree mode.
7	Navigation Keys	Scroll through information or options on the screen.
8	OK Key	Confirms actions or enters the main menu.
9	On-hook Key/Power Key	<ul style="list-style-type: none"> • Press briefly to return to the previous screen. • Long press to return to the idle screen. • Press to turn the handset on. • Long press on the idle screen to turn the handset off. • Cancels actions or ends a call. • Rejects an incoming call.
10	Off-hook Key	<ul style="list-style-type: none"> • Answers an incoming call. • Enters the redial calls list. • Places a call in receiver or headset mode.
11	Keypad	Provides digits, letters, and special characters.
12	TRAN Key	Transfers a call to another party.
13	Mute Key	Toggles mute feature on or off.
14	Microphone	Picks up audio.
15	Speaker	Outputs audio in handsfree mode.
16	3.5 mm Headset Jack	Connects a standard 3.5 mm headset.

W59R Hardware

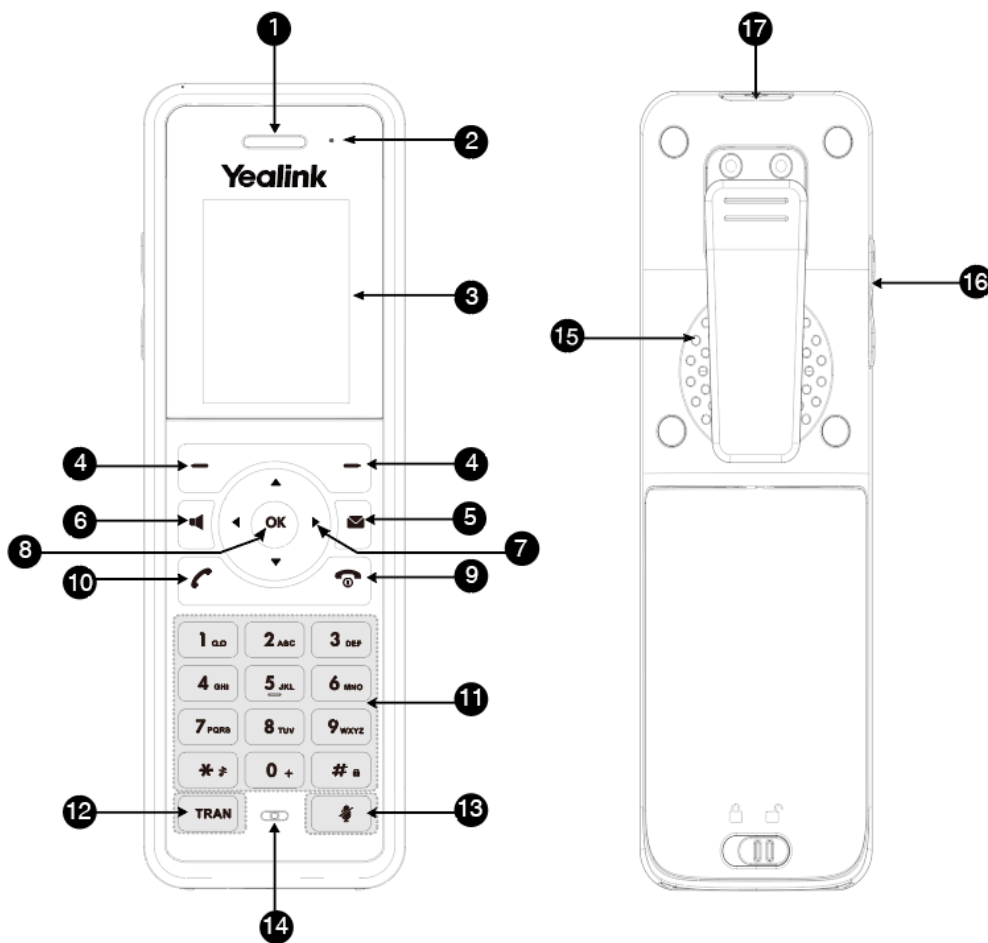

No.	Item	Description
1	Receiver	Receives audio in receiver mode.
2	Power LED Indicator	Indicates call status, message status, and charging status.
3	Phone Screen	Shows information.
4	Soft Keys	Access the function directly. It depends on the operating situation.
5	Message Key	Accesses the voice mail or missed call.
6	Speakerphone Key	<ul style="list-style-type: none"> Switches among the receiver, headset, and handsfree modes. Answers an incoming call. Places a call in handsfree mode.
7	Navigation Keys	Scroll through information or options on the screen.
8	OK Key	Confirms actions or enters the main menu.

No.	Item	Description
9	On-hook Key/Power Key	<ul style="list-style-type: none"> Press briefly to return to the previous screen. Long press to return to the idle screen. Press to turn the handset on. Long press on the idle screen to turn the handset off. Cancels actions or ends a call. Rejects an incoming call.
10	Off-hook Key	<ul style="list-style-type: none"> Answers an incoming call. Enters the redial calls list. Places a call in receiver or headset mode.
11	Keypad	Provides digits, letters, and special characters.
12	TRAN Key	Transfers a call to another party.
13	Mute Key	Toggles mute feature on or off.
14	Microphone	Picks up audio.
15	Speaker	Outputs audio in handsfree mode.

W57R Hardware

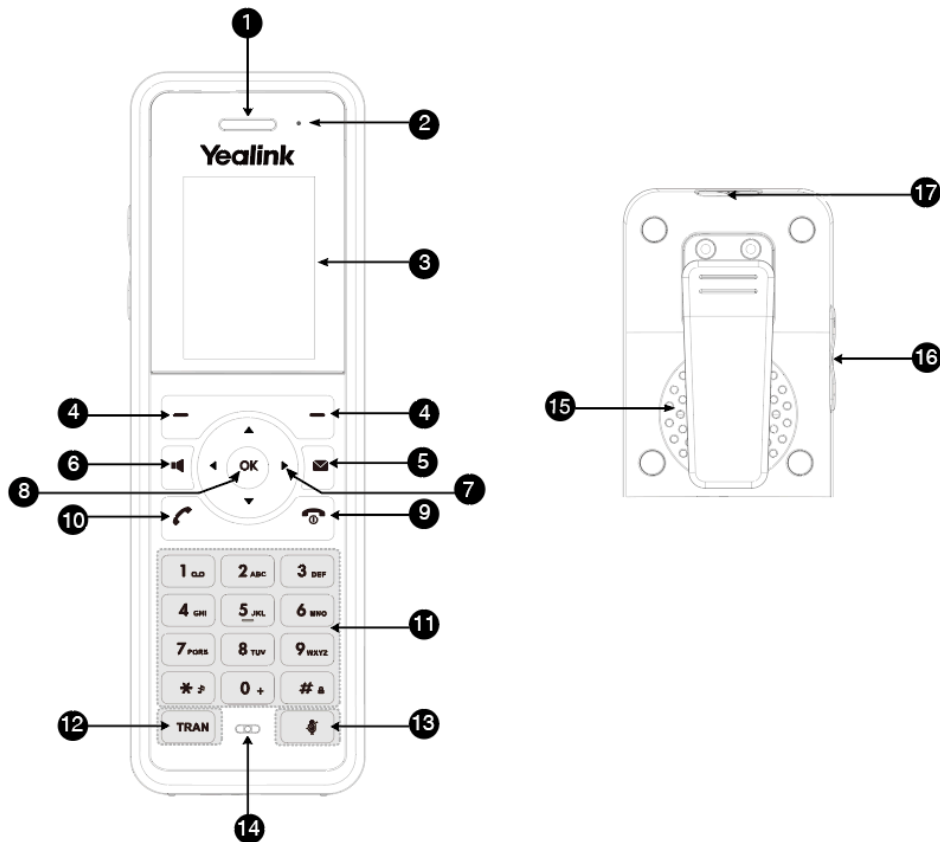

No.	Item	Description
1	Receiver	Receives audio in receiver mode.
2	Power LED Indicator	Indicates call status, message status, and charging status.
3	Phone Screen	Shows information.
4	Soft Keys	Access the function directly. It depends on the operating situation.
5	Message Key	Accesses the voice mail or missed call.
6	Speakerphone Key	<ul style="list-style-type: none"> • Switches among the receiver, headset, and handsfree modes. • Answers an incoming call. • Places a call in handsfree mode.
7	Navigation Keys	Scroll through information or options on the screen.
8	OK Key	Confirms actions or enters the main menu.
9	On-hook Key/Power Key	<ul style="list-style-type: none"> • Press briefly to return to the previous screen. • Long press to return to the idle screen. • Press to turn the handset on. • Long press on the idle screen to turn the handset off. • Cancels actions or ends a call. • Rejects an incoming call.
10	Off-hook Key	<ul style="list-style-type: none"> • Answers an incoming call. • Enters the redial calls list. • Places a call in receiver or headset mode.
11	Keypad	Provides digits, letters, and special characters.
12	TRAN Key	Transfers a call to another party.
13	Mute Key	Toggles mute feature on or off.
14	Microphone	Picks up audio.
15	Speaker	Plays audio in handsfree mode.

W56H Hardware

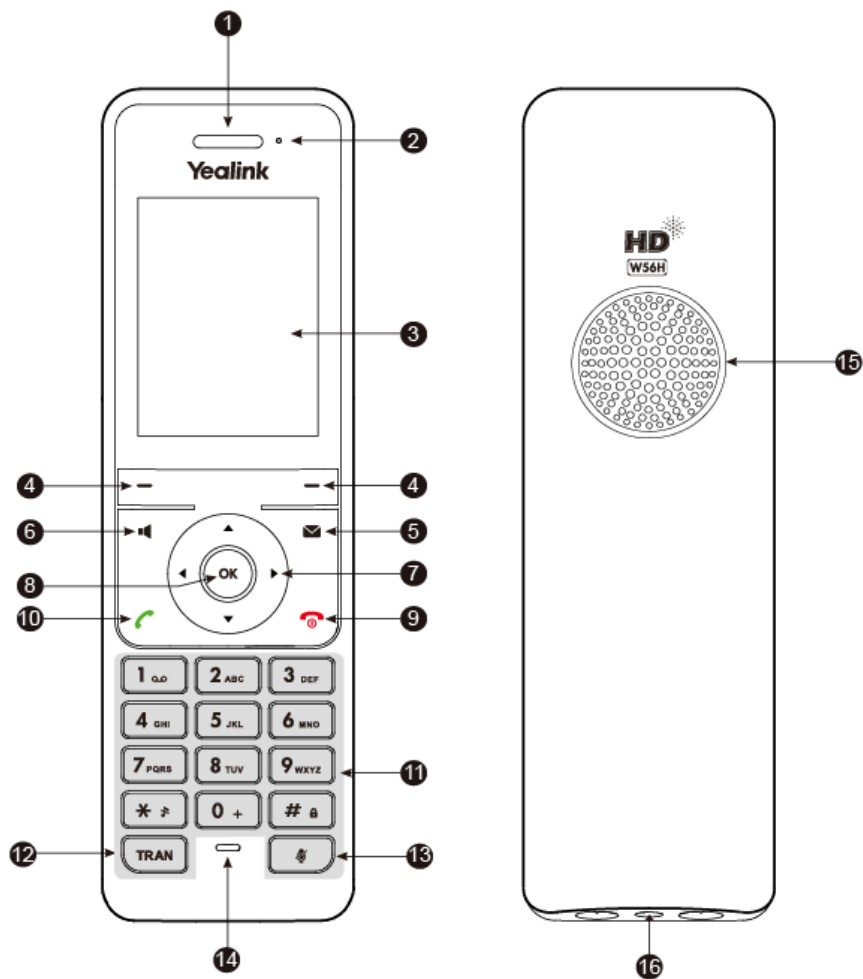

No.	Item	Description
1	Receiver	Receives audio in receiver mode.
2	Power LED Indicator	Indicates call status, message status, and charging status.
3	Phone Screen	Shows information.
4	Soft Keys	Access the function directly. It depends on the operating situation.
5	Message Key	Accesses the voice mail or missed call.
6	Speakerphone Key	<ul style="list-style-type: none"> Switches among the receiver, headset, and handsfree modes. Answers an incoming call. Places a call in handsfree mode.
7	Navigation Keys	Scroll through information or options on the screen.
8	OK Key	Confirms actions or enters the main menu.

No.	Item	Description
9	On-hook Key/Power Key	<ul style="list-style-type: none"> Press briefly to return to the previous screen. Long press to return to the idle screen. Press to turn the handset on. Long press on the idle screen to turn the handset off. Cancels actions or ends a call. Rejects an incoming call.
10	Off-hook Key	<ul style="list-style-type: none"> Answers an incoming call. Enters the redial calls list. Places a call in receiver or headset mode.
11	Keypad	Provides digits, letters, and special characters.
12	TRAN Key	Transfers a call to another party.
13	Mute Key	Toggles mute feature on or off.
14	Microphone	Picks up audio.
15	Speaker	Outputs audio in handsfree mode.

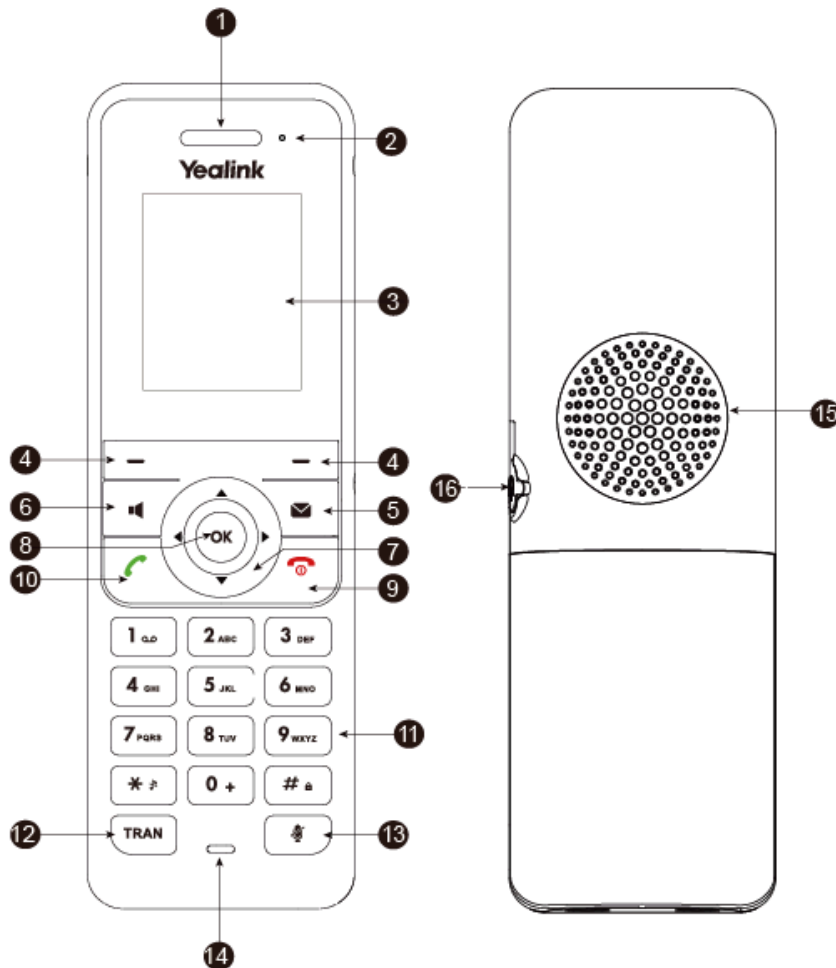

W53H Hardware

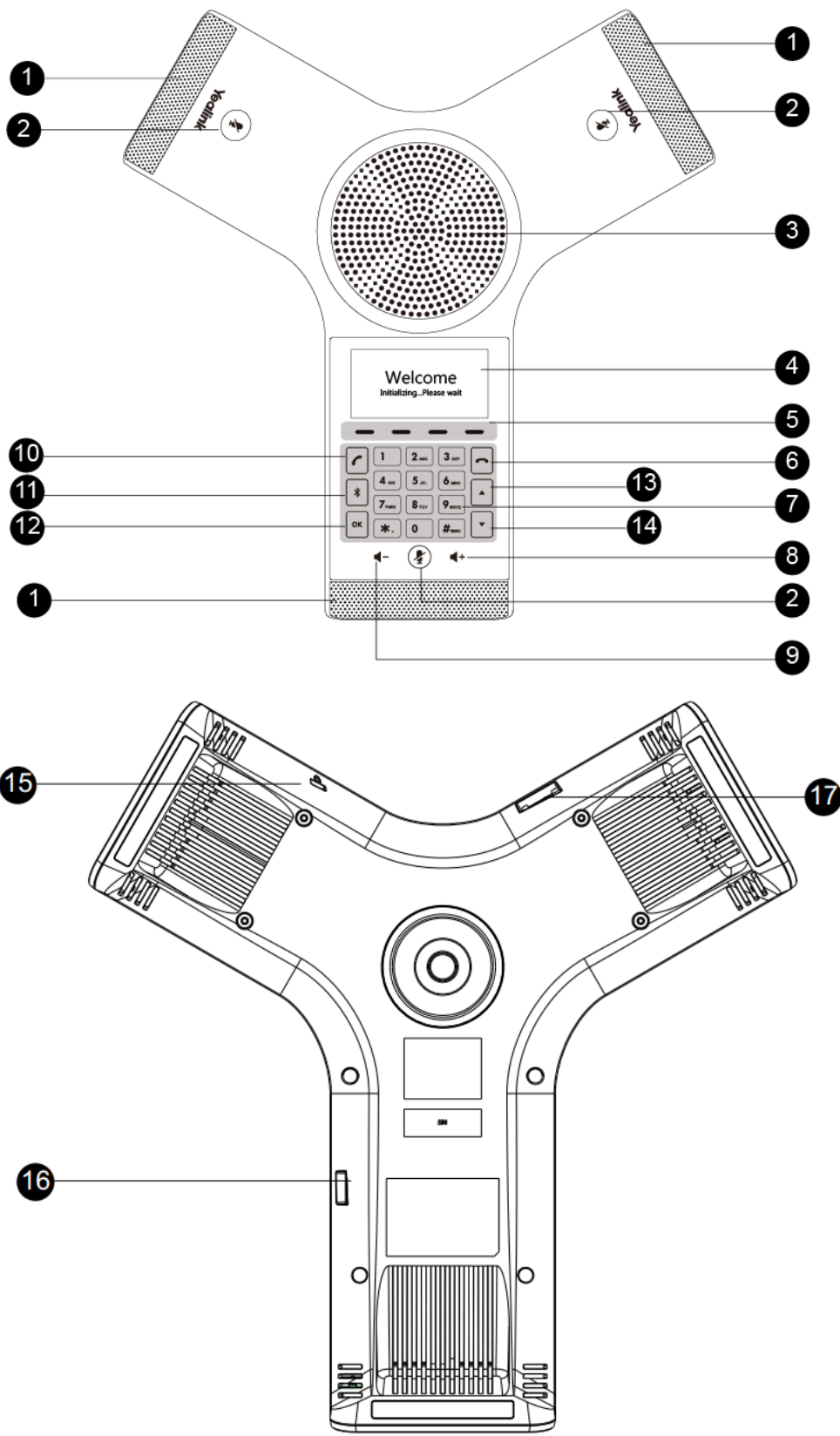

No.	Item	Description
1	Receiver	Receives audio in receiver mode.
2	Power LED Indicator	Indicates call status, message status, and charging status.
3	Phone Screen	Shows information.
4	Soft Keys	Access the function directly. It depends on the operating situation.
5	Message Key	Accesses the voice mail or missed call.
6	Speakerphone Key	<ul style="list-style-type: none"> • Switches among the receiver, headset, and handsfree modes. • Answers an incoming call. • Places a call in handsfree mode.
7	Navigation Keys	Scroll through information or options on the screen.
8	OK Key	Confirms actions or enters the main menu.
9	On-hook Key/Power Key	<ul style="list-style-type: none"> • Press briefly to return to the previous screen. • Long press to return to the idle screen. • Press to turn the handset on. • Long press on the idle screen to turn the handset off. • Cancels actions or ends a call. • Rejects an incoming call.
10	Off-hook Key	<ul style="list-style-type: none"> • Answers an incoming call. • Enters the redial calls list. • Places a call in receiver or headset mode.
11	Keypad	Provides digits, letters, and special characters.
12	TRAN Key	Transfers a call to another party.
13	Mute Key	Toggles mute feature on or off.
14	Microphone	Picks up audio.
15	Speaker	Outputs audio in handsfree mode.

CP930W Hardware



No.	Item	Description
1	Three Internal Microphones	Provide 20-feet (6 meters) and 360-degree sound pickup.
2	Mute Touch Key	<ul style="list-style-type: none"> • Toggles mute feature. • Indicates phone and call status.
3	Speaker	Provides speakerphone audio output.
4	LCD Screen	Shows information about calls, messages, soft keys, time, date and other relevant data.
5	Soft Keys	Labeled automatically to identify their context-sensitive features.
6	On-hook Key	Ends a call, returns to the idle screen or turns off the phone.
7	Touch Keypad	Provides the digits, letters, and special characters in context-sensitive applications. It is possible to open a menu option directly by tapping the number button that corresponds to the position of the option in the menu.
8	Volume Key(+)	Increases the volume of the speaker, ringer, or media.
9	Volume Key(-)	Decreases the volume of the speaker, ringer, or media.
10	Off-hook Key	Enters the dialing screen, places a call or answers a call.
11	Bluetooth Key	Enters the Bluetooth setting screen.
12		Confirms actions or answers incoming calls.
13		Scrolls through the displayed information upwards.
14		<ul style="list-style-type: none"> • Scrolls through the displayed information downwards. • Views the Directory list when the phone is idle.
15	Security Slot	Allows you to connect a universal security cable to your phone so you can lock down your phone. The phone will not be removed after locked.
16	Micro USB Port	Allows you to connect a PC and turn your phone into an external speaker and microphone for your PC.
17	Micro SD Slot	Allows you to connect an SD card to record calls and play recordings on the phone.

CP935W Hardware

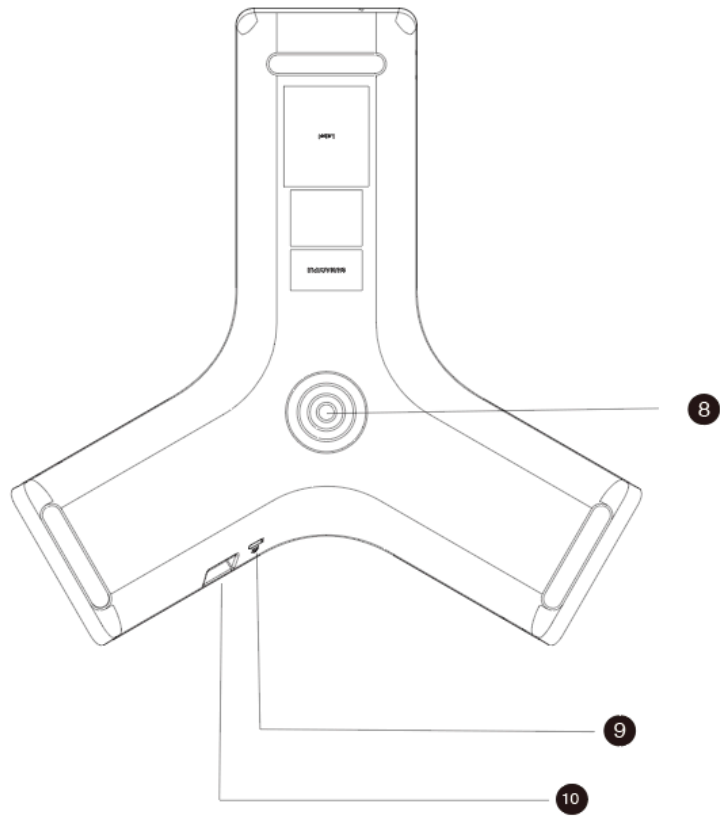
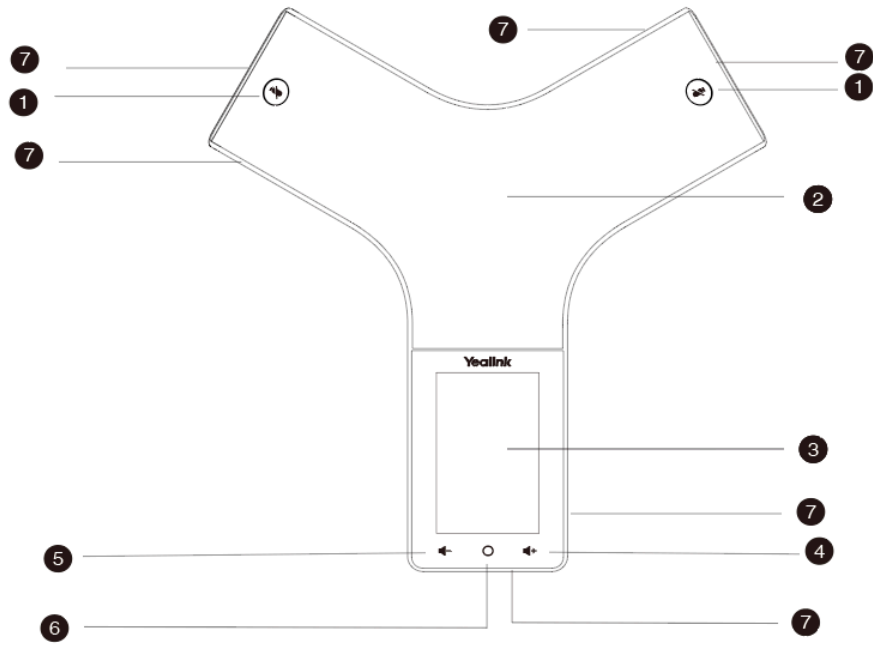

No.	Item	Description
1	Mute Key	<ul style="list-style-type: none"> • Toggles mute feature. • Indicates phone and call status.
2	Speaker	Provides speakerphone audio output.
3	LCD Screen	Shows information about calls, messages, Bluetooth, time, date and other relevant data.
4	Volume Key(+)	Increases the volume of the speaker, ringer, or media.
5	Volume Key(-)	Decreases the volume of the speaker, ringer, or media.
6	Home Button	Long press to power on/off or return to the home page with one-touch.
7	Six Internal Microphones	Provide 20-feet (6 meters) and 360-degree sound pickup.
8	Contact Charging Port	Puts the port to the charging cradle to charge.
9	Security Slot	Allows you to connect a universal security cable to your phone so you can lock down your phone. The phone will not be removed after locked.
10	USB Type-C Port	Allows you to connect a PC and turn your phone into an external speaker and microphone for your PC.

DD Phone Hardware

DD Phone:

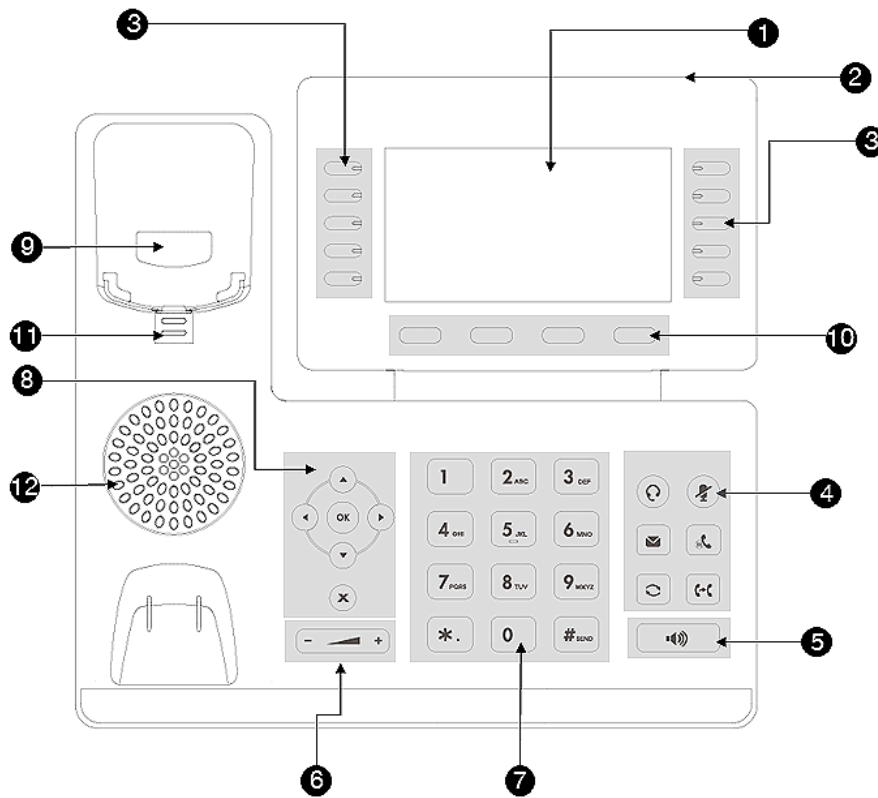

NO.	Item	Description
1	Phone Screen	Shows a screen with backlight that enables you to view menus and data.
2	Power LED Indicator	Indicates call status, message status, and system status.
3	Line Keys	Access your phone outgoing lines and features.
4	HEADSET Key	Toggles the headset on or off. The LED indicator glows green when the headset is activated.
	MUTE Key	Toggles the microphone on or off. The LED indicator glows red when the mute feature is activated.
	MESSAGE Key	Accesses your voice messages.
	HOLD Key	Places an active call on hold or resume the call.
	REDIAL Key	Redials a previously dialed number.
	FORWARD Key	Forward incoming calls of the line to another party.
5	Speakerphone Key	Toggles the speakerphone (hands-free) mode on or off. The LED indicator glows green when the speakerphone is activated.
6	Volume Key	Adjusts the volume of the handset, headset, and speaker.

NO.	Item	Description
7	Keypad Keys	Allow you to enter numbers, letters, and special characters. If a menu item has an index number, you can use the keypad keys to select the item.
8	Navigation Keys	<ul style="list-style-type: none"> • Scroll through information or options displayed on the screen. • Access History and Directory respectively.
	OK Key	Confirms actions or answers incoming calls.
	Cancel Key	Cancels actions or rejects incoming calls.
9	Hookswitch	Connects or disconnects the phone from the phone line. The hookswitch is automatically activated when a user lifts the handset from the cradle to get a dial tone.
10	Soft Keys	Access the function displayed on the screen above the soft keys. The soft keys change depending on what you are doing at the time.
11	Reversible Tab	Secures the handset in the handset cradle when the phone is mounted vertically. For more information on how to adjust the reversible tab, refer to Yealink Wall Mount Quick Installation Guide for Yealink IP Phones .
12	Speaker	Provides ringer and speakerphone audio output.

WHM621/WHD622 with Charging Cable Hardware

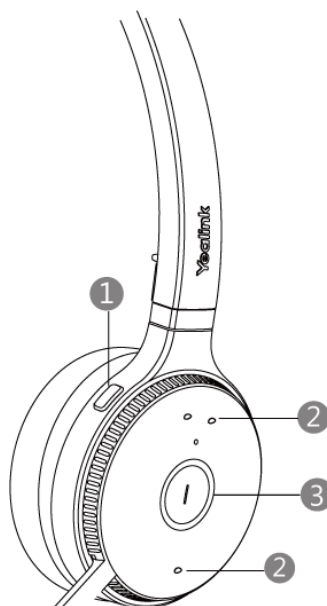

NO.	Item	Description
1	Mute Button	Mute or unmute your microphone.
2	Volume Up/Down Button	Adjust the volume of the headset.
3	Call Control Button	Answer/end/reject/redial a call.

WHM631 with Charging Cable Hardware

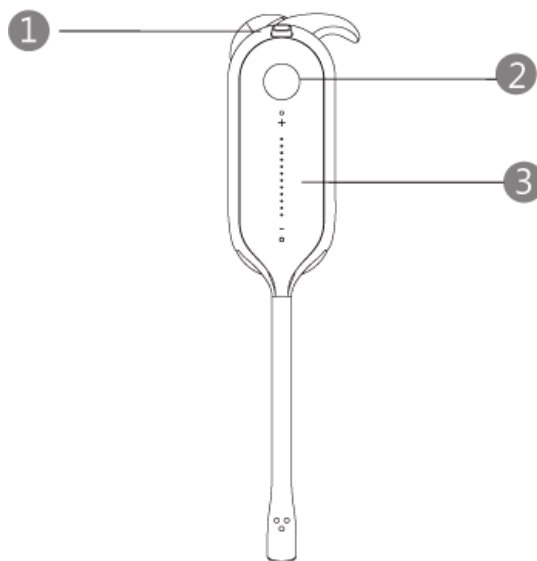

NO.	Item	Description
1	Mute Button	Mute or unmute your microphone.
2	Call Control Button	Answer/end/reject/redial a call.
3	Volume Control Button	Adjust the volume of the headset.

W73H/W78H/W56H/W53H/W59R/W57R Power LED Indicator

LED Status	Description
Solid red	The handset is charging.
Fast flashing red (300ms)	The handset is ringing.
Slowly flashing red (1s)	The handset receives a voice mail or has a missed call.
Off	The handset is powered off. The handset is idle. The handset is fully charged.

CP930W/CP935W Mute Touch Key LED Indicators

The Mute touch key LED indicators indicate the call and phone status.

LED Status	Description
Solid red	The phone is initializing. The phone is muted.
Flashing red	The phone is ringing.

LED Status	Description
Solid green	The phone is placing a call. There is an active call on the phone. The call is placed on hold or is held (It is only applicable to the CP935W).
Flashing orange	The phone prompts low battery or is charging.
Off	The phone is powered off. The phone is idle.

Menu on the W73H/W78H/W56H/W53H/W59R/W57R

The handset provides a variety of features that are grouped into the menu.

- [Main Menu](#)
- [Submenu](#)
- [Returning to Idle Screen](#)

Main Menu





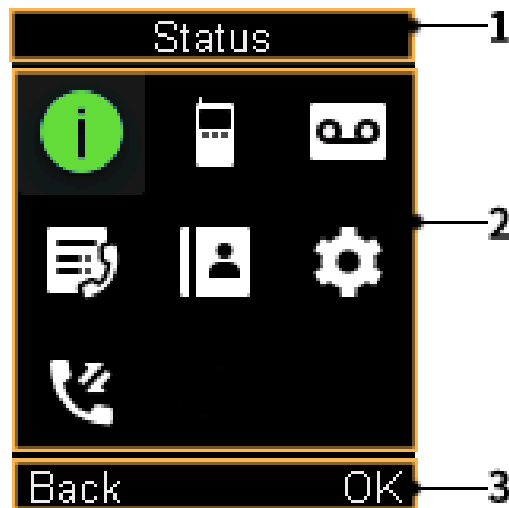



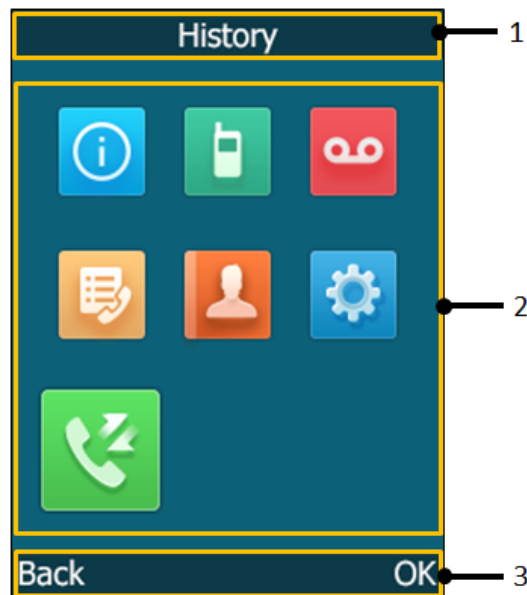







The main menu is the top menu, which consists of seven menu items: Status, Intercom, Voice Mail, Call Features, Directory, Settings, and History.

W73H/W78H:



W56H/W53H/W59R/W57R:



No.	Description
1	Menu item you selected.
2	<p>Menu icon:</p> <p>  : Status—To view the status information of base, handset, and line.</p> <p>  : Intercom—To make an internal call.</p> <p>  : Voice Mail—To set and view voice mail(s).</p> <p>  : Call Features—To access the features of Call Forward, Do Not Disturb, Call Waiting, Anon.Call Rejection, Anonymous Call and Paging.</p> <p>  : Directory—To access the directory and manage the contacts.</p> <p>  : Settings—To personalize the setting of your handset.</p> <p>  : History—To access the call history list.</p> <p> Note: If your system administrator has enabled 3-level access permissions for you, you can see a User Mode icon  .</p>
3	Soft key label.

- [Entering the Main Menu](#)
- [Accessing the Main Menu Feature](#)

Entering the Main Menu

You can enter the main menu to view the features.

Procedure

Press the OK key when the handset is idle.

The main menus are displayed on the screen as icons.

Accessing the Main Menu Feature

After entering the main menu, you can use the navigation keys to access the desired menu.

Procedure

1. Press the OK key when the handset is idle.
The main menus are displayed on the screen as icons.
2. Press the navigation keys to select a different menu icon.
The name of the associated menu appears on the top of the screen.
3. Press **OK** to open the selected menu.



Note: You can only access **Status** and **Settings** if the handset is not registered to a base station.

Submenu

The functions in the submenus are displayed as lists. You can open the submenu to access a function.

For example, if you select the **Settings** menu, the submenu is displayed below:

W73H/W78H:

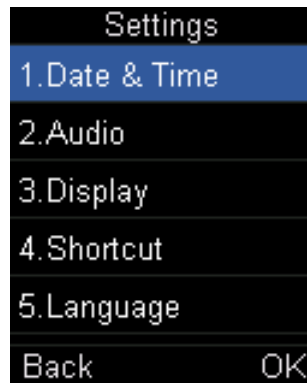

W56H:

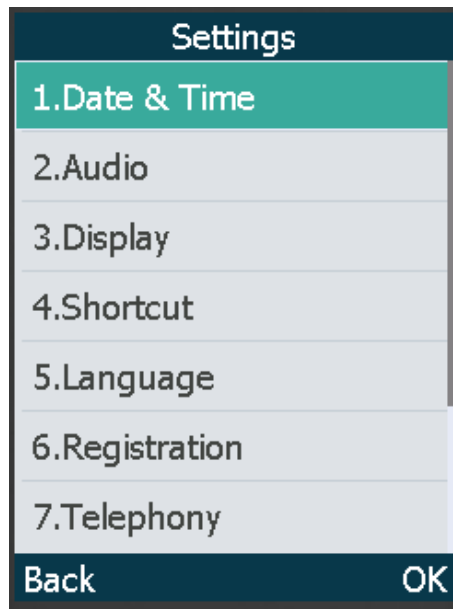

W53H/W59R/W57R:

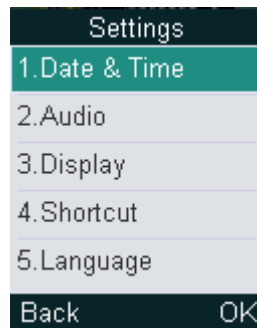

- [Accessing a Submenu Feature](#)

Accessing a Submenu Feature

After entering a certain menu, you can use the navigation keys to access the desired submenu.

Procedure

1. Press the up and down navigation keys to highlight the desired submenu.
2. Press **OK** to open the submenu.
3. Press the On-hook key or **Back** to return to the previous screen.

Returning to Idle Screen

Procedure

Long press the On-hook key to quickly exit the menu and return to the idle screen.

Screen and Icons

The user screens and icon indicators can help you navigate and understand the important information on the phone's status.

- [Idle Screen](#)
- [Calls Screen of CP930W](#)
- [Calls Screen of CP935W](#)
- [W73H/W78H/W56H/W53H/W59R/W57R Line Status Screen](#)
- [Icons on the Idle Screen](#)
- [W73H/W78H/W56H/W53H/W59R/W57R Icons on the Calls Screen](#)
- [W73H/W78H/W56H/W53H/W59R/W57R Icons on the Line Status Screen](#)

Idle Screen

The idle screen is made up of the signal strength, battery status, status bar, handset name, and soft keys. The time & date is displayed in the middle of the screen.

On the CP930W/DD phone/CP935W, the default account also displays on the idle screen.

W73H:



W78H:



W59R/W57R/W56H/W53H:

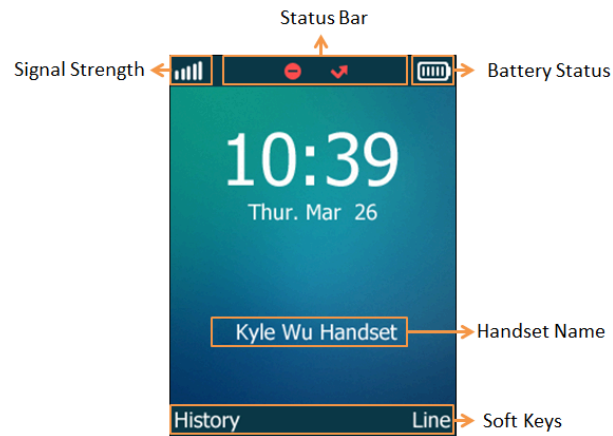

CP930W:



DD Phone:

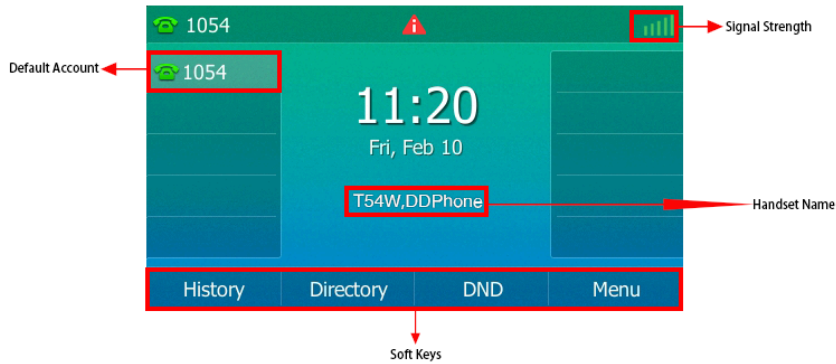

CP935W:





• **Signal Strength:**



Weak to strong: (W59R/W57R/W56H/W53H/W73H/W78H/CP935W),
 (CP930W), (DD phone)

No reception: (W59R/W57R/W56H/W53H/W73H/W78H), (CP930W), (DD phone/CP935W)

Eco mode+ is on:

- **Battery Status:**

Low to full:  (W59R/W57R/W56H/W53H/W73H/W78H),
 (CP930W),  (CP935W)

Need Charging:  (W59R/W57R/W56H/W53H/W73H/W78H),  (CP930W),  (CP935W)

- **Status Bar:** Displays the feature status icons. The status icons are displayed when features are activated.
- **Handset Name:** Displays internal handset number and registered handset name (for example, “1” is internal handset number, indicating the handset is the Handset 1 of the base station).
- **Soft Keys:** The soft key labels on the screen directly above the soft keys show the functions available at that particular moment. (It is not applicable to CP935W).

Calls Screen of CP930W

All of your active and held calls are displayed on the calls screen.

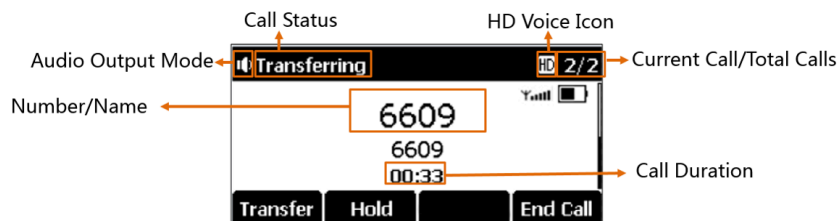

Calls Screen of CP935W

All of your active and held calls are displayed on the calls screen.

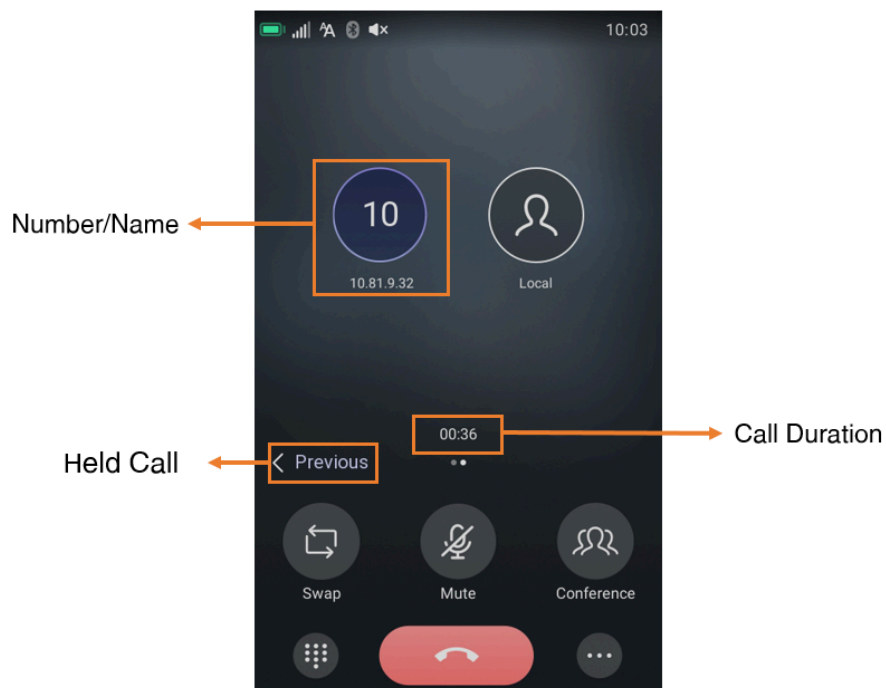

W73H/W78H/W56H/W53H/W59R/W57R Line Status Screen

The line status screen is made up of the outgoing line and line status.

When the handset is idle, you can press **Line** to enter the line status screen. The line status screen is displayed below:

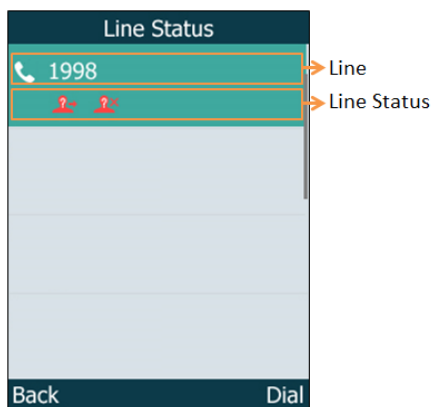

- **Outgoing Line:** Display the registered line number and the corresponding line (display user name by default). The default outgoing line will be displayed in the first line of the screen.
- **Line Status:** Display the icon of line status. The icon indicates the corresponding feature assigned to the line.

Icons on the Idle Screen







By viewing the icons on the idle screen, you can easily get the current phone status, such as message status.

W59R/W57R/W56H/W53H/W73H/W78H:







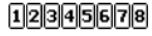





Icons	Description	Icons	Description
	The ringer volume is 0 and the phone is in the silent mode.		The phone has new voice mails.
	The phone has enabled the Call Forward feature.		The phone has enabled the Do Not Disturb (DND) feature.
	The keypad is locked.		

CP930W:











Icons	Description	Icons	Description
	The ringer volume is 0 and the phone is in the silent mode.		The phone has enabled the Do Not Disturb (DND) feature.
	The phone has enabled the Call Forward feature.		The phone has new voice mails.
	The keypad is locked.		The phone failed to register to a base station.
	The phone is in the Speakerphone (hands-free) mode.		The Bluetooth-enabled mobile phone is paired and connected to the phone.

Icons	Description	Icons	Description
	The phone has registered to a base station successfully.		The SD card is connected to the phone.
	The phone has enabled the Bluetooth feature.		The battery is not inserted into the phone.
	The phone is recording a call or a conference.		The phone has missed calls.
	The recording is paused.		Registered handset icon (for example, "1" is internal phone number, indicating the phone is the Handset 1 of the base station)

CP935W:







Icons	Description	Icons	Description
	The ringer volume is 0 and the phone is in the silent mode.		The phone has enabled the Do Not Disturb (DND) feature.
	The phone has enabled the Always Forward feature.		The phone has missed calls.
	The phone has enabled the Busy Forward feature.		The phone has enabled the Auto Answer feature.
	The phone has enabled the No Answer Forward feature.		The microphone has been muted.
	The phone has registered to a base station successfully.		The phone failed to register to a base station.
	The phone has enabled the Bluetooth feature.		The phone has new voice mails.
	The Bluetooth-enabled mobile phone is paired and connected to the phone.		

DD Phone:

Icons	Description	Icons	Description
	The ringer volume is 0 and the phone is in the silent mode.		The phone has enabled the Do Not Disturb (DND) feature.
	The phone has enabled the Call Forward feature.		The phone has new voice mails.
	The phone is in the handset mode.		The phone has missed calls.
	The phone is in the headset mode.		The phone is locked.
	The phone is in the Speakerphone (hands-free) mode.		The private line registers successfully.
	The shared line registers successfully.		





W73H/W78H/W56H/W53H/W59R/W57R Icons on the Calls Screen

By viewing the icons in the calls screen, you can easily get the current call status, such as audio output mode status.

Icons	Description	Icons	Description
 (not available to W73H/W78H)	Receiver Mode On		Headset Mode On
	Handsfree Mode On	 (not available to W73H/W78H)	Contact
	Call Hold		Call Mute
	Conference Call		

W73H/W78H/W56H/W53H/W59R/W57R Icons on the Line Status Screen

Each icon in the line status screen indicates the corresponding feature assigned to the line.

Icons	Description	Icons	Description
	Call Forward		Do Not Disturb (DND)
	Anonymous call rejection is enabled		Anonymous call is enabled
	Unassigned outgoing line		

Rechargeable Battery

The CP930W/CP935W phone comes with a charged battery, but it may need recharging to full capacity depending on how long it has been in storage.

CP930W: A fully-charged battery provides talk time of about 24 hours or 15 days of standby time.

CP935W: A fully-charged battery provides talk time of about 20 hours or 167 hours of standby time.

- [Viewing the Power Status](#)
- [Power Saving Mode](#)

Viewing the Power Status

When the phone is idle, you can check the battery's remaining capacity.

Procedure

Go to **Menu > Status > Power Status**.

On the CP935W, go to **More > Status > Power Percent**.

The screen shows the remaining talk time and standby time.

Power Saving Mode

The power saving feature is used to turn off the backlight and screen to conserve energy. The CP935W enters power-saving mode after it has been idle for a certain period of time.



Note: It is only applicable to CP935W.

Procedure:

Go to **More > Basic > Power Saving**.

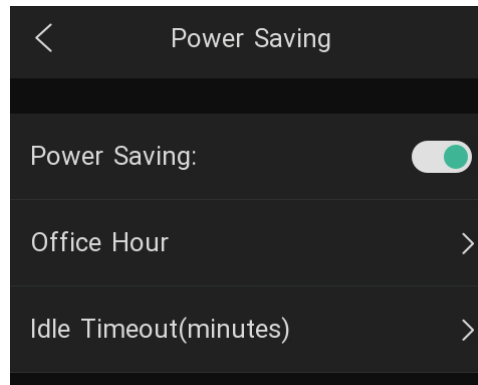

Parameter	Description
Office Hour	Tap to add working hours according to your needs.
Idle Timeout (Minutes)	<ul style="list-style-type: none"> • Office Hour Idle Timeout: It configures the time (in minutes) to wait in the idle state before the phone enters power-saving mode during office hours. Valid value: integer from 1 to 960. • Off Hour Idle Timeout: It configures the time (in minutes) to wait in the idle state before phone enters power-saving mode during the non-office hours. Valid value: integer from 1 to 10. • User Input Extension Idle Timeout: It configures the minimum time (in minutes) to wait in the idle state after using the phone before entering the power-saving mode. Valid value: integer from 1 to 30.

Entering Characters

You can enter and edit data in the corresponding field using the keypad.

- [Setting the Input Modes](#)
- [Entering Data on the W73H/W78H/W56H/W53H/W59R/W57R](#)
- [Entering Data on the CP930W/DDPhone](#)
- [Entering Data on the CP935W](#)

Setting the Input Modes

The handset provides you with 12 input modes, and different input mode provides different characters. The default input modes are Abc, 123, ABC and abc. You can enable the input modes used frequently.

About this task

It is not applicable to DD phones/CP935W.

Procedure

1. Go to **OK > Settings > Display > Input Method**.

On the CP930W, go to **Menu > Settings > Basic Settings > Display > Input Method**.

2. Select the desired input mode and then select **Change**.

Related information

[Appendix B - Input Modes and Characters](#)

Entering Data on the W73H/W78H/W56H/W53H/W59R/W57R

The following table describes how to enter different characters using the keypad keys:

Task	Action
Switch among input modes.	Press [#*] to switch among input modes. The current input mode is displayed at the right bottom of the phone screen.
Enter letters.	Press a key one or more times (depending on what input mode you're in) to enter the possible characters that are displayed on the keypad key.
Enter special characters.	Press [*#] to enter the space character or the following special characters: _ ' " = / \ ^ ; : , . - + * # \$ % & @ ? ! ; i () { } [] < > ¥ £ \$ ~ □ Press [0+] : <ul style="list-style-type: none"> • If it is in the uppercase (ABC), uppercase and lowercase (Abc) or lowercase (abc) input modes, it will provide space character and the following special characters: . , ? ! 0 • If it is in the numeric (123) input mode, it will only provide the digit 0. • Long press the key to enter the character +.
Delete the text.	Press ← / - or → / + to position the cursor to the right of the text you want to delete, and then press Delete to delete one character at a time or long press to delete all characters.

Entering Data on the CP930W/DDPhone

The following table describes how to enter different characters using the keypad keys.

Task	Action
Switch input modes	Press the ABC, abc, Abc, 2aB, or 123 soft key to switch the input modes.
Enter letters	Select ABC, abc, 2aB, or Abc mode.
Enter numbers	Select 123 mode and press the corresponding keys.
Enter special characters	Select ABC, abc, 2aB, or Abc mode, press * key or # key one or more times to enter one of the following special characters: # key: #



Task	Action
Insert space	Select ABC , abc , 2aB , or Abc mode, press the 0 key.
Delete one or more characters	

Entering Data on the CP935W

The following table describes how to enter different characters using the onscreen keyboard.

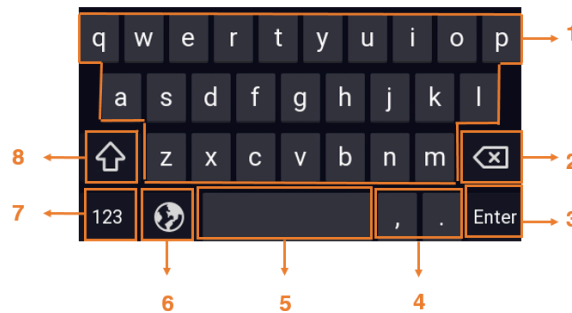

English Input Method:



No.	Item	Description
1	26 English Letters	Tap to enter letters.
2	Delete Key	<ul style="list-style-type: none"> Tap to delete the entered characters one by one. Long tap to delete two or more characters.
3	Done Key	Tap to confirm the settings.
4	Two Special Characters	Tap to enter special characters.
5	Space Key	Tap to enter spaces.
6		Long tap to switch the input modes.
7		Tap to switch to the numeric&symbolic input mode.
8		Tap to switch to the uppercase input mode.

Tap  to switch to the numeric&symbolic input mode as shown below:





No.	Item	Description
1	Numbers	Tap to enter numbers.
2	Special Characters	Tap to enter special characters.
3	Delete Key	<ul style="list-style-type: none"> Tap to delete the entered characters one by one. Long tap to delete two or more characters.
4	Done Key	Tap to confirm the settings.
5	Space Key	Tap to enter spaces.
6		Long tap to switch the input modes.
7		Tap to switch to the lowercase input mode.
8		Tap to switch to the symbolic input mode.

Tap  to switch to the symbolic input mode as shown below:



No.	Item	Description
1	Special Characters	Tap to enter special characters.
2	Delete Key	<ul style="list-style-type: none"> Tap to delete the entered characters one by one. Long tap to delete two or more characters.
3	Done Key	Tap to confirm the settings.
4	Space Key	Tap to enter spaces.

No.	Item	Description
5		Long tap to switch the input modes.
6		Tap to switch to the lowercase input mode.
7		Tap to switch to the numeric&symbolic input mode.

Handset Registration

You need to register your handset to a base station, if you want to use the basic functions of the DECT phone. You can register a handset to 4 different base stations at most. You can select the desired base to use.

 **Note:** Up to 10 handsets can be registered to one base station.

- [Putting the Base Station into the Registration Mode](#)
- [Registering a New Handset to a Base Station](#)
- [Registering a Handset to Another Base Station](#)
- [Possible Reasons for Registration Failure](#)
- [Selecting a Base Station to Connect](#)
- [Renaming the Base Station](#)
- [Deregistering a Handset](#)

Putting the Base Station into the Registration Mode

Before registering the handset, you have to put the base station into the registration mode.

About this task

1. Long press  on the base station till the registration LED flashes.

The base station is now in the registration mode.

 **Note:** If the base station does not identify a DECT phone within 90 seconds, the registration mode will switch off automatically.

Registering a New Handset to a Base Station

With one touch, you can quickly register your new handset to a base station.

Before you begin

Make sure the base station is in the registration mode, and the phone prompts "Unregistered!".

Procedure

Press the **Reg** soft key to register the handset.

The handset is searching for a base station in registration mode.

After the handset is registered successfully, the phone prompts “Handset Subscribed” and “Base NO. (The last 4 characters of the connected Base’s MAC address)”.

After the handset initialized successfully, an icon with the internal handset number and handset name appears on the phone screen.

-  **Tip:** You can also press **OK > Register Handset** and then select the desired base to register the handset. You need to enter the base PIN (default: 0000) after a base is found.

On the CP935W, press **More > Basic > Registration**.

Related tasks

[Putting the Base Station into the Registration Mode](#)

Registering a Handset to Another Base Station

You can register the handset to another base station if you want to discard the current registration.

Before you begin

Make sure the base station is in the registration mode.

Procedure

1. Go to **OK > Settings > Registration > Register Handset**.

On the CP930W, go to **Menu > Settings > Registration > Register Handset**.

On the CP935W, go to **More > Basic > Registration > Register**.

On the DDPPhone, go to **Menu > Basic Settings > Registration > Register Handset**.

2. Select the desired base and then press **OK**.

The handset begins searching for the base station which is in registration mode.

3. Press **OK** after a base is found.

4. Enter the base PIN (default: 0000), and then press **Done** to complete the registration.

After registration, the phone prompts “Handset Subscribed” and “Base NO. (the last 4 characters of the connected Base’s MAC address)”.

After the handset initialized successfully, an icon with the internal handset number and handset name appears on the phone screen.

Related tasks

[Putting the Base Station into the Registration Mode](#)

Possible Reasons for Registration Failure

Some scenarios may cause registration failure.

- Incorrect base PIN (check with your system administrator).
- Base station is out of range.
- Base station is not in registration mode.

-  **Note:** If registration was not successful, the handset screen will prompt you that the registration is failed.

Selecting a Base Station to Connect

You can connect the handset to a desired base station manually, or allow the handset to connect the registered base station with the greatest signal strength automatically.

About this task

It is only applicable to W73H/W78H/W56H/W53H/W59R/W57R.

Procedure

1. Go to **OK > Settings > Registration > Select Base**.

The phone screen displays all base stations that the handset is registered to and the **BestBase** option. The radio box of the currently used base station with the last 4 characters of MAC address is marked.

2. Select the desired base station or **BestBase**, and then press **Select**.

The handset begins to search for a base station. After a successful connection, the phone prompts you the selection is successful.

Renaming the Base Station

You can rename the registered base station to make it easy to discern.

About this task

It is only applicable to W73H/W78H/W56H/W53H/W59R/W57R.

Procedure

1. Go to **OK > Settings > Registration > Select Base**.
2. Select a desired base station (expect **Bestbase** option), and then press **Rename**.
3. Enter the desired name in the **Rename** field.
4. Confirm the action.

Deregistering a Handset

You may need to de-register your own handset if you want to replace a base station.

Procedure

1. Go to **OK > Settings > Registration > De-reg. Handset**.

On the CP930W, go to **Menu > Settings > Registration > De-reg. Handset**.

On the DDPPhone, go to **Menu > Basic Settings > Registration > Delete Register Handset**.

On the CP935W, go to **More > Basic > Registration > Delete**.

2. Enter the base PIN (default: 0000), and then press **Done** or **OK**.

The handset screen displays the handsets names that are registered to the same base station. The name of the handset itself is highlighted and followed by a left arrow.

3. Select the desired handset, and then press **OK**.

The handset screen prompts you whether to de-register the handset.

4. Confirm the action.

Headsets Registration

You can register the headsets to the W70B to answer incoming calls or pair the headsets with the handsets. This chapter will take WH62 as an example.

About this task

This feature is only applicable to the following headsets:

1. WH62/WH63
2. WH62 Mono Portable/WH62 Dual Portable/WH63 Portable
3. WHM621 with Charging Cable/WHD622 with Charging Cable/WHM631 with Charging Cable

To use this feature, please make sure the headset and the base meet the following firmware version requirements:

1. W70B firmware: 146.85.0.35 or later.
2. WH62/WH63/WHM621/WHD622/WHM631 with Charging Cable: 104.432.0.30 or later.
3. WH62/WH63 Portable: 104.432.0.25 or later.

- [Switching Modes](#)
- [Registering a New Headset to a Base Station](#)
- [Pairing the Headset with a Handset](#)
- [Using the Headset to Manage Calls](#)

Switching Modes

The WH62/WH63 have two modes: Registration mode and Normal headset mode. Under the Registration mode, the **Voice** button will glow solid white; under the normal headset mode, the **PC** button will turn solid white.

About this task

This feature is only applicable to the WH62/WH63 headsets.

Procedure

Hold the **Voice** button and **Phone** button of the headset base for 5 seconds. The LED on the headset base will flash for 5 seconds, and the **Voice** button will finally turn solid white.

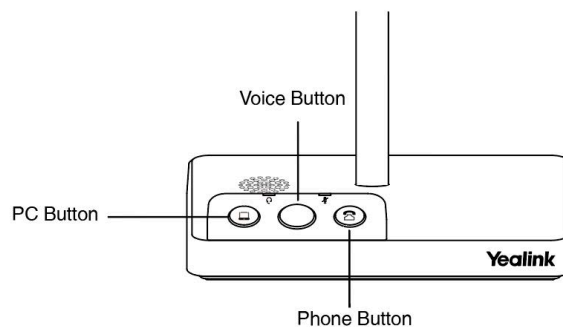

After switching the headset to the Registration mode, you can register it to the W70B.

Registering a New Headset to a Base Station

Procedure

1. [Put the W70B into registering mode.](#)
2. Hold the **Call Control** button for 3 seconds to power off the headset.

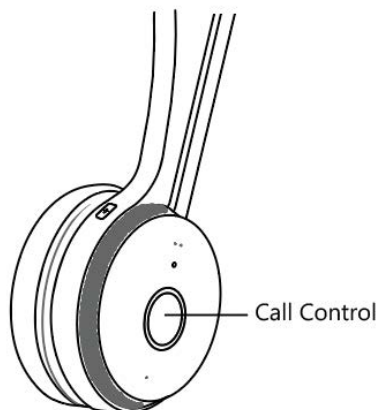

3. Hold the **Call Control** button for 5 seconds to power on the headset, and then it will enter the registration mode automatically. You can see the **Call Control** button flashes blue and hear the voice prompt announcing “**Power on > Pairing mode**”.

After the headset and W70B are all in the registration mode, the headset will automatically register to the W70B. When the **Call Control** button flashes blue, and the voice prompts “**Headset connected**”, it means the headset register to the W70B successfully.

Pairing the Headset with a Handset

You can also pair the headset with a handset registered on the same W70B. The headset will get the same extension number as the handset.

About this task

Please ensure that you have registered the headset and the handset to the W70B. For more information about registering handsets, please refer to [Registering the Handset](#).

Procedure

On the web user interface, go to **Account > Number > Assignment**. Check the account you want to share with the handset.

Number Assignment										
Incoming Lines										
Handset No.	Line No.&Name									
	1 134001	2 134002	3 134003	4 134004	5 134005	6 134006	7 134007	8 134008	9 134009	10 134010
Handset 1	<input checked="" type="checkbox"/>	<input checked="" type="checkbox"/>	<input type="checkbox"/>	<input type="checkbox"/>	<input type="checkbox"/>	<input type="checkbox"/>	<input type="checkbox"/>	<input type="checkbox"/>	<input type="checkbox"/>	<input type="checkbox"/>
Handset 2	<input type="checkbox"/>	<input checked="" type="checkbox"/>	<input type="checkbox"/>	<input type="checkbox"/>	<input type="checkbox"/>	<input type="checkbox"/>	<input type="checkbox"/>	<input type="checkbox"/>	<input type="checkbox"/>	<input type="checkbox"/>
Handset 3	<input type="checkbox"/>	<input type="checkbox"/>	<input checked="" type="checkbox"/>	<input type="checkbox"/>	<input type="checkbox"/>	<input type="checkbox"/>	<input type="checkbox"/>	<input type="checkbox"/>	<input type="checkbox"/>	<input type="checkbox"/>
Handset 4	<input type="checkbox"/>	<input type="checkbox"/>	<input type="checkbox"/>	<input checked="" type="checkbox"/>	<input type="checkbox"/>	<input type="checkbox"/>	<input type="checkbox"/>	<input type="checkbox"/>	<input type="checkbox"/>	<input type="checkbox"/>
Handset 5	<input type="checkbox"/>	<input type="checkbox"/>	<input type="checkbox"/>	<input type="checkbox"/>	<input checked="" type="checkbox"/>	<input type="checkbox"/>	<input type="checkbox"/>	<input type="checkbox"/>	<input type="checkbox"/>	<input type="checkbox"/>
Handset 6	<input type="checkbox"/>	<input type="checkbox"/>	<input type="checkbox"/>	<input type="checkbox"/>	<input type="checkbox"/>	<input checked="" type="checkbox"/>	<input type="checkbox"/>	<input type="checkbox"/>	<input type="checkbox"/>	<input type="checkbox"/>
Handset 7	<input type="checkbox"/>	<input type="checkbox"/>	<input type="checkbox"/>	<input type="checkbox"/>	<input type="checkbox"/>	<input type="checkbox"/>	<input checked="" type="checkbox"/>	<input type="checkbox"/>	<input type="checkbox"/>	<input type="checkbox"/>
Handset 8	<input type="checkbox"/>	<input type="checkbox"/>	<input type="checkbox"/>	<input type="checkbox"/>	<input type="checkbox"/>	<input type="checkbox"/>	<input type="checkbox"/>	<input checked="" type="checkbox"/>	<input type="checkbox"/>	<input type="checkbox"/>
Handset 9	<input type="checkbox"/>	<input type="checkbox"/>	<input type="checkbox"/>	<input type="checkbox"/>	<input type="checkbox"/>	<input type="checkbox"/>	<input type="checkbox"/>	<input type="checkbox"/>	<input checked="" type="checkbox"/>	<input type="checkbox"/>
Handset 10	<input type="checkbox"/>	<input type="checkbox"/>	<input type="checkbox"/>	<input type="checkbox"/>	<input type="checkbox"/>	<input type="checkbox"/>	<input type="checkbox"/>	<input type="checkbox"/>	<input type="checkbox"/>	<input checked="" type="checkbox"/>

Using the Headset to Manage Calls

You can use the headset to manage calls, for example, push calls, retrieve calls and redial.

Procedure

- Push:** After pairing the headset with a handset, the headset and handset will ring when there is an incoming call. If you answer the call on the handset, go to **Options > Push** on the handset to push the call to the headset.
- Retrieve:** After pairing the headset with a handset, when you answer the call in the headset, you can hold the **TRAN** key on the handset to retrieve the call to the handset.
- Redial:** Double press the **Call Control** button on the headset to directly call the last call record.

Call Features

You can use the phone to place and answer calls, ignore incoming calls, transfer a call to someone else, conduct a conference call and perform other basic call features.

- [Changing the Default Outgoing Line](#)
- [Placing Calls](#)
- [Answering Calls](#)
- [Disabling Call Waiting](#)
- [Switching Among the Receiver, Handsfree and Headset Modes](#)
- [Silencing or Rejecting Incoming Calls](#)
- [Ending Calls](#)
- [Muting/Unmuting Audio](#)
- [Holding and Resuming Calls](#)
- [Call Forward](#)
- [Transferring Calls](#)
- [Conference Calls](#)
- [Recording Using an SD Card](#)
- [Multicast Paging](#)

Changing the Default Outgoing Line

Only the outgoing line(s) assigned by your system administrator can be used to place calls. When multiple outgoing lines are assigned to the handset, the first one will be the default outgoing line. You can change the default outgoing line of the handset.

About this task

It is only applicable to W73H/W78H/W56H/W53H/W59R/W57R.

Procedure

1. Go to **OK > Settings > Telephony > Default Line**.

The phone displays all the assigned outgoing lines. The default outgoing line is highlighted and followed by a left arrow.

2. Highlight the desired line, and then press **OK**.

The default outgoing line is changed successfully.

Placing Calls

After the handset is registered to the base station successfully, you can use your handset to place an internal or external call.

The handset can keep 2 (for CP930W/CP935W is 4) calls at one time at almost, one (associated with the audio) active and the other one on hold.

- [Placing Internal Calls](#)
- [Placing External Calls](#)
- [Placing a Call from the Call History](#)
- [Placing a Call from the Directory](#)
- [Placing a Call from the Shared Directory](#)
- [Speed Dial on the W73H/W78H/W56H/W53H/W59R/W57R](#)
- [Speed Dial on the DD Phone](#)
- [Speed Dial on the Headset](#)
- [Redial](#)
- [Placing an Anonymous Call](#)
- [Calling Emergency Alarm Number](#)

Placing Internal Calls

Intercom is a useful feature in the office to quickly contact with the operator or the secretary. Internal intercom calls are made between handsets registered to the same base station.

- [Setting Auto Intercom](#)
- [Placing an Internal Call](#)
- [Placing an Internal Call During an External Call](#)

Setting Auto Intercom

You can set the auto intercom type to make your handset more personalized.

About this task

It is only applicable to W73H/W78H/W56H/W53H/W59R/W57R.

The following types of auto intercom feature are available:

- **On (Beep On):** The handset answers an internal intercom call automatically and plays a warning tone.
- **On (Beep Off):** The handset answers an internal intercom call automatically without a warning tone.
- **Off:** The auto intercom feature is off. You need to answer an internal intercom call manually.

Procedure

1. Go to **OK > Settings > Telephony > Auto Intercom**.
2. Select the desired option, and then press **Change**.

Placing an Internal Call

You can place an internal call to the desired handset or all handsets.

Procedure

1. Go to **OK > Intercom**.
On the CP930W/DDPhone, go to **Menu > Intercom**.
On the CP935W, go to **More > Intercom**.
2. Select the desired handset or **All Handsets**.
3. Select **OK** or the Off-hook key.

On the CP935W, tap the desired handset or **All Handsets** or tap  behind the desired handset to place an internal call.

*If you select **All Handsets**, all other subscribed handsets will ring simultaneously.*



Note: The headsets can answer an intercom call from other handsets but cannot place an intercom to other handsets.

Placing an Internal Call During an External Call

During an external call, you can place a call to an internal line.

Procedure

1. Select **Options > Intercom**.
On the CP930W/CP935W, go to **Hold > New Call > Intercom**.
On the DDPhone, go to **Conference > Intercom**.
2. Select the desired handset, and then press **OK** key or **Send**.
On the CP935W, tap the desired handset directly to place an internal call.

Placing External Calls

You can place external calls on the handset. External calls based on the public telephone network require the SIP lines.



Note: Your system administrator needs to assign the SIP line as the outgoing line for the handset beforehand.

- [Placing an External Call](#)
- [Placing Multiple External Calls](#)

Placing an External Call

Procedure

1. Enter the desired number using the keypad.

On the CP935W, tap  and enter the desired number using the dialpad.

2. Press the **OK** key or **Off-hook Key** to dial out.

On the CP935W, tap  to dial out.

Placing Multiple External Calls

When you are in a call, you can hold your current call and place a new call.

Procedure

1. Select **New Call**.

On the DD phone, select **Hold > New Call**.

On the CP935W, tap  > **New Call**.

2. Enter the contact number and press the **OK** key.

On the CP935W, enter the contact number and tap .

 **Note:** You can select **Options > Directory** to select a contact from the directory to dial out. On the CP930W/DD phone/CP935W, select **Hold > New Call > Directory**.

Placing a Call from the Call History

You can place calls to contacts from the History list, which contains the calls that were recently placed, answered, or missed.

Procedure

1. Press **History** or go to **OK > History**.
2. Select the desired call list.
3. Highlight a contact and press the **Off-hook** or **Send** key.

On the CP935W, select the desired contact directly to dial out.

Placing a Call from the Directory

You can place a call to a contact directly from your directory.

Procedure

1. Go to **OK > Directory**.

On the CP930W/DD phone/CP935W, select **Directory** or **Menu > Directory**.

2. Select the desired directory.

3. Highlight the desired contact and press the **Off-hook** key or **Send**.

On the CP935W, select the desired contact and tap .

If the selected contact has multiple numbers, highlight the desired number, and select **OK**.

Placing a Call from the Shared Directory

You can place a call to a contact directly from your shared directory.

About this task

It is not applicable to DD phones.

Procedure

1. Go to **OK > Directory > Shared Directory**.

On the CP930W/CP935W, select **Directory** or **Menu > Directory**.

2. Highlight the desired contact and press .

On the CP935W, select the desired contact and tap .

If the selected contact has multiple numbers, highlight the desired number, and select **OK**.

Speed Dial on the W73H/W78H/W56H/W53H/W59R/W57R

You can quickly dial a number by using a speed dial key without entering the directory.

- [Assigning a Speed Dial Number](#)
- [Changing a Speed Dial Number](#)
- [Deleting a Speed Dial Number](#)
- [Calling a Contact Using a Speed Dial Key](#)

Assigning a Speed Dial Number

You can assign a contact number to the digit key as a speed dial number. A maximum of 8 speed dial numbers are allowed.

Before you begin

The assigned number should exist in the directory.

Procedure

1. Go to **OK > Settings > Telephony > Speed Dial**.

The phone screen displays all available speed dial keys (2-9).

2. Highlight the desired digit key, and then press **Assign**.
3. Select **Directory**: select the desired contact from the directory; or select **Edit** to customize the **Name** and **Number**.
4. Press **OK** to assign the number to the selected speed dial key.

If the selected contact has multiple numbers, select the desired number, and select **OK**.

Changing a Speed Dial Number

You can change the current speed dial number to a new desired one.

Before you begin

The assigned number should exist in the directory.

Procedure

1. Go to **OK > Settings > Telephony > Speed Dial**.
2. Highlight an assigned speed dial key.
3. Select **Options > Change**.
4. Select **Directory** to select the desired contact from the directory; or select **Edit** to customize the **Name** and **Number**.
5. Press **OK** to change the assigned speed dial number.

Deleting a Speed Dial Number

You can delete the speed dial number when you no longer use it.

Procedure

1. Go to **OK > Settings > Telephony > Speed Dial**.
2. Highlight the desired speed dial key.
3. Select **Options > Clear Key**.

Calling a Contact Using a Speed Dial Key

After you have assigned the speed dial number, you can place a call to a contact directly by pressing it.

Procedure

Long press the speed dial key when the handset is idle.
The number assigned to this speed dial key is dialed out.

Related tasks

[Assigning a Speed Dial Number](#)

Speed Dial on the DD Phone

You can quickly dial a number by using a speed dial key without entering the directory.

- [Configuring a Speed Dial Key](#)

Configuring a Speed Dial Key

You can set a line key as a speed dial key for a contact number.

Procedure

1. Go to **Menu > Features > Dsskey**.
2. Select the desired line key.
3. Select the **SpeedDial** from the **Type** field.
4. Optional: Enter the string that will appear on the LCD screen in the **Label** field.
5. Enter the number you want to dial out in the **Value** field.
6. Confirm the action.

Speed Dial on the Headset

You can quickly dial a number on the headset. A headset can only set one speed dial number.

Before you begin

Your system administrator has set the speed dial number for your headset.

Procedure

Double press the **Call Control** button when the headset is idle.
The number assigned to the headset speed dial feature is dialed out.

Redial

You can redial a call from the redial list.

For W73H/W78H/W56H/W53H/W59R/W57R, the redial list stores the last twenty dialed phone numbers. For DD phone, the redial list stores the last eighteen dialed phone numbers. When the memory of the redial list is full, the handset will automatically erase the oldest one when a new number is dialed.

It is not applicable to CP930W/CP935W.

- [Redialing a Number](#)
- [Redialing the Last Dialed Number](#)
- [Adding a Dialed Number to Local Directory](#)
- [Deleting a Redial Record](#)
- [Deleting All Redial Records](#)

Redialing a Number

The handset keeps a record of all the placed calls. You can call the recently dialed phone number.

Procedure

1. Press  when the handset is idle to access the redial list.

On the DD phone, press  when the phone is idle to access the redial number list.

2. Select a record to dial out.

 **Note:** Before placing an external call on W73H/W78H/W56H/W53H/W59R/W57R, you can select **Options > Edit Before Call** to edit the phone number.

Redialing the Last Dialed Number

Procedure

Press  twice when the handset is idle.

On the DD phone, press  twice.

A call to your last dialed number is attempted.

Adding a Dialed Number to Local Directory

You can add a dialed external call number to the Local Directory or update the number for an existing contact.

About this task

It is only applicable to W73H/W78H/W56H/W53H/W59R/W57R.

Procedure



1. Press  when the handset is idle to access the redial list.
2. Highlight the desired record.
3. Press **Options**, and then select **Add To Local > New Entry**.
4. Select the type you want to add the number to.
5. Edit the corresponding fields.
6. Confirm the action.

 **Note:** You can select **Add To Local > Update Existing** to add the number to an existing contact or update the existing contact information.

Deleting a Redial Record

You can delete any record from the redial list.



Procedure

1. Press  when the handset is idle to access the redial list.
On the DD phone, press  when the phone is idle to access the redial number list.
2. Highlight the desired record.
3. Press **Options** and select **Delete**.
On the DD phone, select **Delete**.

Deleting All Redial Records

You can delete all redial records at once.

Procedure

1. Press  when the handset is idle to access the redial list.
On the DD phone, press  when the phone is idle to access the redial number list.
2. Select **Options** > **Delete All**, and select **Yes** to confirm.
On the DD phone, select **Delete All**.

Placing an Anonymous Call

You can hide your name and number when you place a call. As a result, the callee receives an anonymous call without caller identity.

Before you begin

Contact your system administrator to find out if this feature is available on your phone.

Procedure

1. Go to **OK** > **Call Features** > **Anonymous Call**.
On the CP930W/DD phone, go to **Menu** > **Features** > **Anonymous Call**.
On the CP935W, go to **More** > **Features** > **Anonymous Call**.
2. Select the desired line.
The phone screen displays the outgoing lines currently assigned to the handset. The default outgoing line is highlighted and followed by a left arrow.
3. Enable local anonymous.
4. Confirm the action.
5. Place a call.
The callee is prompted with an incoming call from anonymity.
If the callee enables anonymous rejection feature, you may be prompted that the callee does not accept calls from an anonymous number.

Calling Emergency Alarm Number

The alarm settings are configured on the base station. Ten emergency alarms can be assigned to each individual handset.

Before you begin

Contact your system administrator to find out if this feature is available on your handset.

About this task

It is only applicable to W59R/W57R.

Procedure

Press the emergency alarm button for 2 seconds to dial the number.



Answering Calls

When you receive a call, you can choose to answer it manually or automatically.

- [Assigning Incoming Lines to the Handset](#)
- [Answering a Call](#)
- [Answering a Call When in a Call](#)
- [Answering a Call Automatically](#)

Assigning Incoming Lines to the Handset

You can assign one or more incoming lines for the handset. The handset can only receive incoming calls of the assigned incoming line(s).

About this task

It is not applicable to CP930W/CP935W.

Procedure

1. Go to **OK > Settings > Telephony > Incoming Lines**.

On the DDPPhone, go to **Menu > Advanced Settings(default PIN: 0000) > Incoming Lines** .

2. Enter the system PIN (default: 0000), and then press **Done**.

The handset screen displays all registered handsets. The handset itself is highlighted and followed by a left arrow.



3. Select the desired handset.
4. Select **Accept** from the desired line fields.
5. Confirm the action.

Answering a Call

When you receive an incoming call, the phone rings and the screen displays the information of the incoming call.

Procedure

Do one of the following:

- Press , or press **Accept** or **Answer**.
- Press the Speakerphone key.
- If a headset is connected, press **Accept** or the HEADSET key .

Answering a Call When in a Call

You can answer a call when there is already an active call on your phone.

When you are in an active call and an incoming call arrives on the phone, a call waiting tone beeps, and the incoming call information is displayed.

Procedure

1. On the W73H/W78H/W56H/W53H/W59R/W57R, press the down navigation key to select the incoming call.
2. Select **Accept** or **Answer**.

Results

The active call is placed on hold, and the incoming call becomes active.



Note: You can disable the call waiting feature to reject the incoming call automatically during a call.

Related tasks

[Disabling Call Waiting](#)

Answering a Call Automatically

When the handset is placed in the charger, you can simply answer the incoming calls by picking up the handset from the charger without pressing the Off-hook key.

About this task

It is only applicable to W73H/W78H/W56H/W53H/W59R/W57R/CP935W.

Procedure

1. Go to **OK > Settings > Telephony > Auto Answer**.
On the CP935W, go to **More > Auto Answer**.
2. Press **Change** to select the **Auto Answer** check box (the default status is checked).
On the CP935W, tap the **Auto Answer** icon and enable function directly.

Disabling Call Waiting

If the call waiting feature is disabled, when there is already a call, the new incoming call will be rejected automatically.

Procedure

1. Go to **OK > Call Features > Call Waiting**.
On the CP930W/DD phone, go to **Menu > Features > Call Waiting**.
On the CP935W, go to **More > Features > Call Waiting**.
2. Disable call waiting.
3. Confirm the action.

Switching Among the Receiver, Handsfree and Headset Modes

You can select the desired mode before placing a call, or can alternate among receiver, handsfree, and headset modes during a call.

About this task

You can place a call using the following call modes:

- Receiver mode—pressing the Off-hook key to dial out.
- Handsfree mode—pressing the Speakerphone key to dial out.
- Headset mode—connecting a standard 3.5mm headset.

Silencing or Rejecting Incoming Calls

When you receive an incoming call, you can choose to silence or reject the call instead of answering.

- [Silencing a Call](#)
- [Rejecting a Call Manually](#)
- [Rejecting Anonymous Calls](#)
- [Rejecting Calls with Do Not Disturb \(DND\)](#)

Silencing a Call

You can silence a call to stop your phone from ringing. Even if you silence the call, the incoming call notification continues to be displayed on your phone.

Procedure

Select **Silence**.

Rejecting a Call Manually

You can reject a call manually, and the call may be sent to voice mail. The rejected calls are displayed in the Received Calls list in your History list.

Procedure

Press  or **Reject**.

Rejecting Anonymous Calls

You can reject incoming calls from the callers who have hidden their identities. As a result, your phone will not ring and you will not be notified of an attempted call.

Procedure

1. Go to **OK > Call Features > Anon.Call Rejection**.
On the CP930W, go to **Menu > Features > Anon.Call Rejection**.
On the DD phone, go to **Menu > Features > Anonymous Call**.
On the CP935W, go to **More > Features > Anonymous Call**.
2. Select the desired line.
3. Enable local anonymous rejection.

4. Confirm the action.

Rejecting Calls with Do Not Disturb (DND)

You can enable DND to reject all incoming calls automatically when you do not want to be interrupted.

Before you begin

Check with your system administrator to find out if the DND feature is available on your phone.

Procedure

1. Go to **OK > Call Features > Do Not Disturb**.

On the CP930W/DD phone, go to **Menu > Features > DND**.

On the CP935W, go to **More > Features > DND**.

2. Select the desired line, and then press **OK**.
3. Enable DND.
4. Confirm the action.

The status bar displays the DND icon.

 **Note:** On the CP930W/DD phone, to activate or deactivate DND quickly, select **DND** when the phone is idle.

Ending Calls

You can end the current call at any time.

Procedure

Press  or **End Call**.

Muting/Unmuting Audio

You can mute the microphone during an active call so that the other party cannot hear your discussion with your colleagues.

Procedure

1. Press the mute key during a call to mute the microphone.
The mute icon appears on the phone screen. On the CP930W/CP935W, the mute touch key LEDs change from green to red. On the DDPhone, the mute key LED glows red.
2. Press the mute key again to unmute.
The mute icon disappears from the phone screen. On the CP930W/CP935W, the mute touch key LEDs change from red to green. On the DDPhone, the mute key LED turns off.

 **Note:** On the CP935W, to mute or unmute quickly, you can press the mute key directly.

Holding and Resuming Calls

You can place an active call on hold and resume the call when you are ready. When you place a call on hold, the held party may hear the music played by its sever.

- [Holding a Call](#)
- [Resuming a Held Call](#)

Holding a Call

You can place an active call on hold on your phone.

Procedure

During a call, select **Options** > **Hold**.

On the CP930W/DD phone/CP935W, select **Hold**.



Note: When you have multiple calls on the phone and the current call is held, you can press the up or down navigation key to swap to the active call.

Resuming a Held Call

You can view and resume a held call on the phone.

Procedure

Select **Resume**.

If multiple calls are placed on hold, select the desired call first.



Note: When you have multiple calls on the phone and the current call is active, you can press the up or down navigation key to swap to the held call.

Call Forward

The handset will forward incoming calls to another party according to the forwarding type.

There are three forwarding types:

- **Always Forward:** Incoming calls are immediately forwarded. There is no prompt on the phone screen when the line receives an incoming call.
- **Busy Forward:** Incoming calls are forwarded when the line is busy.
- **No Answer Forward:** Incoming calls are forwarded if not answered after a period of time.
- [Forwarding Incoming Calls](#)

Forwarding Incoming Calls

When you are not available to handle calls, you can forward incoming calls to a specific contact.

Procedure

1. Go to **OK** > **Call Features** > **Call Forward**.

On the CP930W/DD phone, go to **Menu** > **Features** > **Call Forward**.

On the CP935W, go to **More** > **Features** > **Call Forward**.

2. Select the desired line.
3. Select the desired forwarding type and enable it.
4. Enter the destination number in the **Target** or **Forward to** field.
5. If you select the **No Answer (No Answer Forward)**, select the desired ring time to wait before forwarding from the **After Ring Time** field.
6. Confirm the action.

Transferring Calls

During a call, you can transfer the call to another contact.

You can use one of three ways:

- **Blind Transfer:** Transfer a call directly to the third party without consulting.
- **Semi-Attended Transfer:** Transfer a call when receiving ringback.
- **Attended Transfer (Consultative Transfer):** Transfer a call with prior consulting.
- [Performing a Blind Transfer](#)
- [Performing a Semi-Attended/Attended Transfer](#)

Performing a Blind Transfer

You can transfer a call to another contact immediately without consulting with her/him first.

Procedure

1. Select **Options > (Call) Transfer**, or press the TRAN key during a call.

On the CP930W/DD phone, select **Transfer**.

On the CP935W, tap **⋮** and select **Transfer**.

2. Enter the number you want to transfer the call to or select **Directory > Directory/History** to choose a contact.
3. Press TRAN or **Transfer** to complete the transfer.

On the DD phone, select **B Transfer**.

Performing a Semi-Attended/Attended Transfer

You can transfer a call to another contact immediately when receiving ringback or after consulting with her/him first.

Procedure

1. Select **Options > (Call) Transfer**, or press the TRAN key during a call.

On the CP930W/DD phone, select **Transfer**.

On the CP935W, tap **⋮** and select **Transfer**.

2. Enter the number you want to transfer to and dial out.

On the CP935W, enter the number you want to transfer to and select **Transfer > Call**.

3. Do one of the following:

- When you hear the ringback tone, press the TRAN key or **Transfer** to finish a semi-attended transfer.
- After the contact answers the call, press the TRAN key or **Transfer** to finish an attended transfer (consultative transfer).

Conference Calls

The phone supports creating a conference with other two external parties and multi-way network conference. The CP930W/CP935W supports creating local conference, a seven-way hybrid UC meeting (the CP935W supports creating a five-way hybrid meeting) and network conference.

During the conference, follow these tips:

- Mute your microphone when you are not speaking, especially in noisy environments.
- Avoid tapping or rustling papers near the microphone.
- Speak in your normal voice without shouting.
- [Local Conference](#)
- [Hybrid UC Meeting](#)
- [Network Conference](#)

Local Conference

You can initiate a three-way (including yourself) conference calls with your contacts on the phone. You can initiate a five-way (including yourself) conference calls with your contacts on the CP930W/CP935W.

- [Setting Up a Local Conference Call](#)
- [Merging Two Calls into a Conference](#)
- [Inviting an Incoming Call to a Conference](#)
- [Holding or Resuming a Conference Call](#)
- [Muting/Unmuting a Conference Call](#)
- [Splitting a Conference Call](#)
- [Managing Conference Participants](#)
- [Ending a Conference Call](#)

Setting Up a Local Conference Call

You can set up a local conference call with up to two contacts.

Procedure

1. Place a call to the first party.
2. When the first party answers the call, select **Options > Conference**.
On the CP930W, select **Conf.**.
On the DD phone/CP935W, select **Conference**.
The active call is placed on hold.
3. Dial the second party's number.
4. When the second party answers the call, select **Conf.** to invite two parties to join the conference.
On the DD phone/CP935W, select **Conference**.

Merging Two Calls into a Conference

You can invite a held call into a conference call with the active call.

Procedure

1. Place two calls on the phone.
2. Select **Options > Conference**.
On the CP930W, select **Conf.**.
On the DD phone/CP935W, select **Conference**.

Inviting an Incoming Call to a Conference

You can create a conference when the phone receives an incoming call during the call(s) or a conference.

About this task

It is only applicable to CP930W/CP935W.

Procedure

Tap **Join** when the phone receives a new call.

On the CP935W, tap **Join Conf**.

The conference among the original call(s) and the incoming call is set up. If you are in a conference, the new party will join the conference.

Holding or Resuming a Conference Call

When you place a conference call on hold, other participants cannot hear each other until you resume the held conference call.

About this task

It is only applicable to CP930W/CP935W.

Procedure

1. Tap **Hold** to place the conference on hold.
2. Tap **Resume** to resume the held conference call.

Muting/Unmuting a Conference Call

When you mute the local microphone during a conference call, other participants can hear each other except you.

Procedure

1. Press the MUTE key to mute the conference.
2. Press the MUTE key again to unmute the conference.

Splitting a Conference Call

You can split the conference call into individual calls. After the split, the conference call ends, and other parties are held.

About this task

It is not applicable to DD phones.

Procedure

Select **Split**.

On the CP930W, select **Manage > Split All**.

On the CP935W, tap  and select **Split**.

Managing Conference Participants

You can manage the conference participants to make the conference more flexible.

About this task

It is only applicable to CP930W/CP935W.

Procedure

1. During a conference call, select **Manage**.

On the CP935W, long tap the icon of participant directly.

2. Select the desired party, you can do the following:

- Select **Far Mute** to mute the party. The muted party can hear everyone, but no one can hear the muted party.
- Select **Remove** to remove the party from the conference call.

Ending a Conference Call

You can end the current conference call at any time.

Procedure

Press  or **End (End Call)**.

On the CP935W, press .

Hybrid UC Meeting

You can create a hybrid UC meeting on the CP930W/CP935W by different ways.

 **Note:** It is only applicable to CP930W/CP935W.

- [Creating a Hybrid UC Meeting with Mobile Phone](#)
- [Creating a Hybrid UC Meeting with PC](#)
- [Creating a Hybrid UC Meeting with Mobile Phone and PC](#)

Creating a Hybrid UC Meeting with Mobile Phone

When you are talking on your mobile phone and want to invite colleagues, you can create a hybrid UC meeting on the phone.

Procedure

1. During the mobile call, active the Bluetooth feature on your mobile phone.
2. Connect and pair the phone on your mobile phone.
3. Switch the audio input mode to Bluetooth on your mobile phone.
4. Select **Conf**, then enter the desired number to dial out or press **Directory** to select a contact.

On the CP935W, press **New Call**.

5. After the second party answers the call, select **Conf**.

On the CP935W, press  > **Merge Calls**.

6. Repeat steps 4-5 to invite more parties (up to 4 parties).

Creating a Hybrid UC Meeting with PC

When you are talking with your contact on the PC and want to invite colleagues, you can create a hybrid UC meeting on the phone.

Procedure

1. Connect the phone to a PC using a micro USB cable.

On the CP935W, connect to a PC using a Type C cable.

2. Select **Hold** > **New Call**.

3. Enter the desired number to dial out or press **Directory** to select a contact.

4. After the second party answers the call, select **Conf**.

On the CP935W, select **Merge Calls**.

5. Repeat steps 2-4 to invite more parties (up to 4 parties).

Creating a Hybrid UC Meeting with Mobile Phone and PC

You can create a hybrid UC meeting on the phone with mobile phone and PC simultaneously.

Procedure

1. Connect and pair the phone on your mobile phone.
2. Connect the PC to your phone by using the micro USB cable.
On the CP935W, connect the PC to your phone by using the Type C cable.
3. Place a call using the softphone on the PC.
4. Do the following to place a mobile call over Bluetooth on the phone.
 - a) Select **Hold > New Call**.
 - b) Select **Switch** to choose the **Mobile Account**.

On the CP935W, press  to choose the **Mobile Line**.

- c) Enter the desired number.
- d) Select **Send** or .

On the CP935W, press .

5. Do the following to place a SIP call on the phone.
 - a) Select **Conf**.

On the CP935W, select **New Call**.

- b) Enter the desired number.
- c) Select **Send** or .

On the CP935W, press .

6. Repeat the step 5 to invite more parties (up to 4 parties).
7. Select **Conf**.

On the CP935W, press  > **Merge Calls**.

Network Conference

If your system administrator has set a network conference feature on your phone, you can initiate a conference with two or more contacts.

- [Setting Up a Network Conference](#)
- [Inviting another Party into an Active Conference Call](#)
- [Holding/Resuming a Conference Call](#)
- [Ending a Conference Call](#)

Setting Up a Network Conference

You can set up a network conference with two or more contacts.

Procedure

1. Place a call to the first party.

2. Select **Options > Conference**.

On the CP930W, select **Conf.**.

On the DD phone/CP935W, select **Conference**.

The active call is placed on hold.

3. Dial the second party's number.

4. When the second party answers the call, select or **Conference** to add the second party to the conference.

On the CP935W, select **Conference** or  > **Merge Calls**.

5. Select **Conf.** or **Conference** to place a new call.

The conference call is placed on hold.

6. Enter the number of the new party, and then press the OK key.

7. When the new party answers the call, select **Conf.** to add the new party to the conference.

On the CP935W, select **Conference** or  > **Merge Calls**.

8. Repeat steps 5 to 7 until you add all parties.



Note: The procedures for setting up a network conference call on specific servers may be different. Contact your system administrator for more information.

Inviting another Party into an Active Conference Call

Any party in the conference call can invite other party into an active conference call.

Procedure

1. Select **New Call**.

On the CP930W/DD phone, select **Conf.** or **Hold > New Call**.

On the CP935W, select **Conference** or  > **New Call**.

2. Enter the desired number and dial out.

3. When the new party answers the call, select **Options > Conference**.

On the CP930W/DD phone, select **Conf.**.

On the CP935W, select **Conference** or  > **Merge Calls**.

The new party is joined the conference call.

Holding/Resuming a Conference Call

Any party in the conference call can place himself/herself on hold, but other parties can continue the conference call normally.

About this task



Note: The conference call will only be held when all parties in the conference call place themselves on hold.

Procedure

1. Select **Options > Hold**.

On the CP930W/DD phone/CP935W, select **Hold**.

2. Select **Resume** to resume the held conference call.

Ending a Conference Call

You can end the current conference call at any time.

Procedure

Press  or **End (End Call)**.

On the CP935W, press .

Recording Using an SD Card

By default, you can record your calls into an SD card so that you can listen to them later.

For more information on how to attach an SD card, please refer to the Quick Start Guide for your phone on [Yealink Support](#).

 **Note:** It is only applicable to CP930W.

- [Recording a Call](#)
- [Pausing/Resuming a Recording](#)
- [Stopping a Recording](#)
- [Managing the Recordings](#)
- [Viewing the Available Recording Time](#)

Recording a Call

You can record the important parts during an active call.

About this task

 **Note:** Before call recording, especially those involving PSTN, it is necessary to know about the rules and restrictions of call recording in the country where you are.

It is also very important to inform all the call parties that you are recording and ask for their consent before recording the conversation.

Procedure

During a call, select **More > StartREC**.

The phone screen displays a recording icon and recording duration.

Pausing/Resuming a Recording

When you do not want the current sensitive information to be recorded, you can pause the recording. After pausing, you can resume it at any time and the recording continues and will be saved in the same file.

Procedure

1. Select **PauseREC** to pause a recording.

The pause recording icon appears on the phone screen and the duration stops counting.

2. Select **Re REC** to resume a recording.

 **Note:** If you hold the call during the recording, none of the parties will be recorded until you resume the call.

Stopping a Recording

You can stop recording a call before the call ends. The recording also stops when the active call ends. The recording will be saved as a "*.aac" file on the SD card automatically.

Procedure

Do one of the following:

- Select **StopREC**.

The recording icon and recording duration disappears. The screen prompts a message that the call is recorded successfully.

- Select **End Call**.

The recording icon and recording duration disappears, and the phone returns to the idle screen. The screen prompts a message that the call is recorded successfully.

Managing the Recordings

After stopping recording, you can manage the recordings on your phone. Make sure the is still inserted in the phone.

- [Listening to a Recording](#)
- [Pausing/Resuming a Playback](#)
- [Fast Forwarding/Rewinding a Playback](#)
- [Deleting a Recorded Call](#)

Listening to a Recording

You can browse and play back the recordings on your phone.

About this task



Note: You can also play back the recordings on a PC using an application capable of playing the "*.aac" file.

Procedure

1. Go to **Menu > Record > Browse Audio**.

The phone screen shows all recorded files (filename and file size). The filename consists of the recording time & date, the other party's number/name (or the first person's number/name you called).

2. Highlight the desired file and select **Play**.

The length of the recording and a progress bar are displayed as the recording plays.

Pausing/Resuming a Playback

When you are playing a recording, you can pause it manually to take note.

Procedure

1. Select **Pause** to pause the playback.
2. Select **Play** to restart the playback.

Fast Forwarding/Rewinding a Playback

While a recording plays, you can fast forward or rewind the playback at any time.

Procedure

Do the following:

- Select ►► to skip forward the playback. Tap once to skip forward 1 minute.
- Select ◀◀ to rewind the playback. Tap once to rewind 1 minute.

Deleting a Recorded Call

You can delete the recordings when you need additional space on your SD card or the recordings are useless.

Procedure

1. Go to **Menu > Record > Browse Audio**.
2. Highlight the desired recording and select **Delete**.
The phone prompts you whether to delete the audio.
3. Confirm the action.

Viewing the Available Recording Time

To avoid the recording failed due to timeout, you can view the storage space of the SD card, and check the available recording time before recording.

Procedure

Go to **Menu > Record > Storage Space**.

Multicast Paging

Multicast Paging allows you to broadcast instant audio announcements to users who are listening to a specific multicast group on a specific channel.

The phone supports the following 31 channels:

- **0:** Broadcasts are sent to channel 0.
- **1 to 25:** Broadcasts are sent to channel 1 to 25. We recommend that you specify these channels when broadcasting with Polycom IP phones which have 25 channels you can listen to.
- **26 to 30:** Broadcasts are sent to channel 26 to 30. We recommend that you specify these channels when broadcasting with Yealink IP phones running firmware version 81 or later running new firmware version (new paging mechanism).



Note: All IP phones in the multicast paging group must be deployed in the same subnet since a broadcast is used. The phone can only send/receive broadcasts to/from the listened channels. Other channels' broadcasts will be ignored automatically by the IP phone.

- [Sending Multicast Paging](#)
- [Receiving Multicast Paging](#)
- [Managing a Paging Call](#)

Sending Multicast Paging

You can send paging to the phones with pre-configured multicast addresses on specific channels.

Before you begin

Your system administrator has set the paging group for your phone.

Procedure

1. Go to **OK > Call Features > Paging**.

On the CP930W/DDPhone, go to **Menu > Features > Paging List**.

On the CP935W, go to **More > Features > Paging List**.

If your system administrator has set only one paging list, the paging is sent directly.

2. Select the desired paging group.
3. Select **Paging**.

On the CP935W, select the desired paging group directly.



Note: Multicast RTP is the one-way paging only from the sender to the multicast address(es) (receiver). For outgoing RTP multicasts, all other existing calls on the phone will be placed on hold.

Receiving Multicast Paging

Your system administrator has set a listening paging group for you, you can automatically receive a paging call when the phone is idle.

When there is a voice call or a paging call in progress, or when DND is activated on your phone, the phone handles the new paging call differently according to the multicast listening settings configured by your system administrator.

Managing a Paging Call

During a paging call, you can manage it manually at any time.

Procedure

You can do the following:

- Select **Hold** to place the current paging call on hold.

The paging call is placed on hold and the receiver releases the session.

- Select **Resume** to resume the held paging call.

The multicast RTP session is re-established.

- Select **End** to end the paging call.

On the CP935W, select .

Advanced Call Features

By using the advanced features, your handset would perform more functions that make your work more efficiently.

If you require additional information or assistance with your new phone, contact your system administrator.

- [Call Park and Call Retrieve](#)
- [Shared Call Appearance \(SCA\)](#)
- [Voice Mail](#)

Call Park and Call Retrieve

You can park a call, and then retrieve the call either from your phone or another phone. After parked, the call is placed on hold, you can continue the conversation after retrieving it.



Note: Call park is not available on all servers. Check with your system administrator to find out if it is available on your phone.

- [Parking or Retrieving a Call in the FAC Mode](#)
- [Parking or Retrieving a Call in the Transfer Mode](#)

Parking or Retrieving a Call in the FAC Mode

You can park the call to the local extension or the desired extension through dialing the park code.

- [Parking a Call in the FAC Mode](#)
- [Retrieving a Parked Call in the FAC Mode](#)

Parking a Call in the FAC Mode

You can park a call in the FAC mode directly. When you park a call to the local extension or the desired extension, the call is held in the same network on your phone.

Before you begin

Your system administrator has set call park in the FAC mode.

Procedure

1. During a call, select **Options > Call Park**.

On the CP930W/DD phone, select **More > Call Park(Park)**.

On the CP935W, select  **> Park**.

The phone will dial the call park code which is pre-configured.

2. Do one of the following:

- If you want to park the call against the local extension, press the # key.
- If you want to park the call against the desired extension, enter the extension (for example, 4606) where you want to park the call and press the # key.

If the call is parked successfully, you will hear a voice prompt that the call is parked.

Retrieving a Parked Call in the FAC Mode

You can retrieve a parked call in the FAC mode from any phone within your network.

Before you begin

Your system administrator has set call park in the FAC mode. There is a call parked on the extension. Get the park retrieve code from your system administrator.

Procedure

1. Dial the park retrieve code.
2. Follow the voice prompt to retrieve:
 - Press the # key on the phone where the call is parked.
 - Enter the desired extension followed by # (for example, 4606#) on any phone.

Parking or Retrieving a Call in the Transfer Mode

You can park the call to the shared parking lot through a blind transfer.

For some servers, the system will return a specific retrieve park number (park retrieve code) after parking successfully.

- [Parking a Call in the Transfer Mode](#)
- [Retrieving a Parked Call in the Transfer Mode](#)

Parking a Call in the Transfer Mode

You can park a call in the transfer mode directly. When you park a call to the shared parking lot, the call is held on your phone.

Before you begin

Your system administrator has set call park in the Transfer mode.

Procedure

During a call, select **Options > Call Park**.

On the CP930W/DD phone, select **More > Call Park(Park)**.

On the CP935W, select  **> Park**.

The call will be directly transferred to the shared parking lot.

Retrieving a Parked Call in the Transfer Mode

You can retrieve a parked call in the transfer mode from any phone in the same network.

Before you begin

Your system administrator has set call park in the Transfer mode. There is a call parked on the shared parking lot.

Procedure

Dial the park retrieve code.

The phone will retrieve the parked call from the shared parking lot.



Note: When the W73H/W78H/W56H/W53H/W59R/DD phone is idle, you can use a **Retrieve** key to retrieve a parked call directly.

Related tasks

[Retrieving a Call with a Retrieve Key](#)

Shared Call Appearance (SCA)

Yealink phone supports using Shared Call Appearance (SCA) to share a line. So that this line can be registered on more than one phone at the same time. Your system administrator can set your phone to use the shared line.

- [W73H/W78H/W56H/W53H/W59R/W57R State Indicator of Shared Line](#)
- [Placing Calls on a Shared Line](#)
- [Answering Calls on a Shared Line](#)
- [Placing a Call on Public Hold](#)
- [Placing a Call on Private Hold](#)
- [Retrieving a Held Call on a Shared Line](#)
- [Barging in an Active Call on a Shared Line](#)

- [Pulling a Shared Call on a Shared Line](#)

W73H/W78H/W56H/W53H/W59R/W57R State Indicator of Shared Line

If your system administrator assigns the shared line to your handset, the SCA with an icon is displayed on the right soft key.

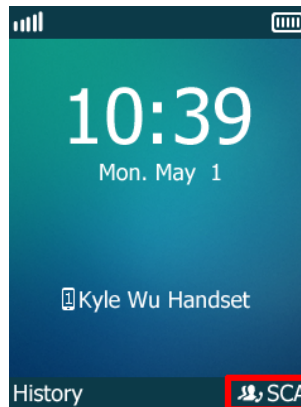

The following table shows the icon associated with the shared line:

Icons	Description
	The shared line is idle.
	The shared line is dialing, in conversation or placed on private hold.
 (Flashing)	The shared line receives an incoming call or is placed on public hold.

Placing Calls on a Shared Line

You can place one or multiple calls on a shared line.

Related information

[Placing Calls](#)

Answering Calls on a Shared Line

You can answer one or two calls on the shared line.

When an incoming call arrives on the shared line, all the registered phones will ring simultaneously, and the call can be answered on any one of the phones.

Related information

[Answering Calls](#)

Placing a Call on Public Hold

You can place a call on public hold that any shared line phone can retrieve the held call.

Procedure

During a call, select **Options** > **Hold**.

On the CP930W/DD phone/CP935W, select **Hold**.

Placing a Call on Private Hold

You can place a call on private hold that only you on shared line can retrieve the held call.

About this task



Note: It is not applicable to the CP935W.

Procedure

During a call, select **Options > Private Hold**.

On the CP930W/DD phone, select **More > PriHold**.

Then the call is held on your phone, and the other phones registered with shared line show the call is in the busy state. Other users on the shared line cannot resume your held call.

Retrieving a Held Call on a Shared Line

If you place a call on hold on a shared line, you can resume this call at any time. When the shared line key shows a call that is in a held state, you can resume the held call remotely from other user's phone.

Before you begin

There is at least one call placed on public hold on the shared line.

Procedure

Select **Resume**.

Barging in an Active Call on a Shared Line

In the SCA scenario, you can barge into an active call on the shared line. After you barge into a call, the call turns into a three-party conference.

Before you begin

There is at least one active call on the shared line. Only one user can barge into an active call on the shared line at a time.

About this task

It is not applicable to CP930W/CP935W.

Procedure

1. Select **SCA** and then select an active call.
2. Select **BargeIn (Barge In)** to interrupt the active call.

Pulling a Shared Call on a Shared Line

In the SCA scenario, both you and other users can pull an existing call from another shared phone that is active or held.

Before you begin

There is an active or held call on the shared line. Contact your system administrator for the call pull feature access code.

It is not applicable to CP930W/CP935W.

Procedure

1. Enter the call pull feature access code (for example, *11).
2. Press the OK key to dial out.

Voice Mail

Voice Mail feature allows you to leave voice mails for someone or listen to your voice mail messages on your IP phones. This feature is set up on the server-side and not all servers support this feature.

- [Setting the Voice Mail Code](#)
- [Setting a Voice Mail Key for a Specific Line](#)
- [Leaving Voice Mails](#)
- [Listening to Voice Mails](#)

Setting the Voice Mail Code

If you want to connect to the message center, you need to set the voice mail code on your phone.

Procedure

1. Go to **OK > Voice Mail > Set Voice Mail**.

On the W73H/W78H, go to **OK > Voice Mail > Status**, select **On** from the **Status** field, and select **Set Number**.

On the CP930W, go to **Menu > Message > Set Voice Mail Code**.

On the CP935W, go to **More > Message > Set Voice Mail Code**.

On the DD phone, go to **Menu > Message > Voice Mail > Set Voice Mail Code**.

2. Select the desired line, and then press **Select**.
3. On the W56H/W53H/W59R, select **Enabled** from the **Status** field.
4. Enter the voice mail code.
5. Confirm the action.

Setting a Voice Mail Key for a Specific Line

You can set digit key 1 as a voice mail key for a specific line. When the handset is idle, you can long press this key, and quickly access the voice mails without scrolling through the menu.

About this task

Note: It is only applicable to W73H/W78H/W56H/W53H/W59R/W57R.

Procedure

1. Go to **OK > Voice Mail > Set Key 1**.
2. Select the desired line, and then press **Select**.

Leaving Voice Mails

You can leave a voice mail to someone who is busy or inconvenient to answer the call.

Procedure

1. Follow the voice prompts to leave a voice mail.

2. Hang up to complete the voice mail.

Listening to Voice Mails

You can listen to your voice mails on the handset directly.

Before you begin

You need to set the voice mail code in advance.

Procedure

1. Go to **OK > Voice Mail > Play Message** or press the Message key.

On the CP930W, go to **Menu > Message > Play Message**.

On the CP935W, go to **More > Message > View Voice Mail**.

On the DD phone, go to **Menu > Message > Voice Mail > View Voice Mail**.

2. Select the desired line, and then press **Select**.

The handset dials out the voice mail code using the selected line automatically.

3. Follow the voice prompt from the system server to listen to your voice mails.



Note: If you have set a voice mail key, you can long press the Voice Mail key to access the voice mail of a specified line.

Push-to-Talk (PTT)

Starting with firmware 146.85.0.35, the push-to-talk feature is available on our handsets, headsets and DD Phone. It allows the handset to be used like a handheld transceiver (walkie-talkie) among the handsets, headsets and DD Phone registered at the same base station.

Before you begin

The handsets, headsets and DD Phone need to be registered on the W70B first.

- [Headset Registration](#)
- [Handset/DD Phone Registration](#)
- [Initiating a PTT Meeting](#)
- [Joining a PTT Meeting](#)
- [Exiting a PTT Meeting](#)
- [Push-to-Talk](#)
- [Listening to the Talk in Real Time](#)

Initiating a PTT Meeting

You can initiate a PTT Meeting. This feature enables the handsets/headsets/DD Phones registered at the same base station to function like an intercom.

Before you begin

Your system administrator has set the PTT group for your phone.

- [Initiating a PTT Meeting on the Handset](#)
- [Initiating a PTT Meeting on the Headset](#)

- [Initiating a PTT Meeting on the DD Phone](#)

Initiating a PTT Meeting on the Handset

You can initiate a PTT Meeting on the handset, and this section will take W73H as an example.

Procedure

1. Long press the **Mute** key to enter the PTT operation screen.
2. Press **Lock** to initiate the PTT meeting.



Initiating a PTT Meeting on the Headset

You can initiate a PTT Meeting on the headset, and this section will take WH63 as an example.

About this task

Refer to the [Headset Registration](#) to see the detailed information about the supported headsets and the firmware version requirement.

Procedure

Long press the **Mute** button and the **Call Control** button. When you hear a **BEEP**, a PTT meeting is initiated.



Initiating a PTT Meeting on the DD Phone

You can initiate a PTT Meeting on the DD Phone, and this section will take T54W as an example.

Procedure

1. Set a Push-to-Talk Line Key on the T54W.
 - a. Go to **Menu > Features > Dsskey**.
 - b. Select the desired line key.
 - c. Select **Push to Talk** from the **Type** field.
 - d. (Optional.) Enter the string that will appear on the phone screen in the **Label** field.
 - e. Select **Save**.
2. Press the PTT Line Key directly to enter the PTT operation screen.
3. Press **Lock** to initiate a PTT meeting.



Joining a PTT Meeting

You can join a PTT meeting directly when someone has initiated one. Your devices will be muted automatically when you join the meeting. You can press the **Mute** key to unmute and speak.

For headsets, when other group members initiate a PTT meeting or make a Push-to-Talk, your headset will join the PTT automatically.

- [Joining the PTT Meeting Without a Prompt](#)
- [Joining the PTT Meeting With a Prompt](#)

Joining the PTT Meeting Without a Prompt

By default, the handsets/headsets/DD Phones will not receive notification of the PTT meeting dialog.

Procedure

1. For handsets: long press **Mute** key to enter the PTT operation screen; at this time, you can listen to the communication of other participants. Press **Lock** key to join the PTT meeting.
2. For DD Phone: press the PTT line key to enter the PTT operation screen, at this time, you can listen to the communication of other participants. Press **Lock** key to join the PTT meeting.

Joining the PTT Meeting With a Prompt

The handsets/headsets/DD Phones will receive notification of the PTT meeting dialog when there is a PTT meeting.

About this task

Contact your system administrator to find out if this feature is available on your phone.

Procedure

1. For handsets: press **Enter** to join.

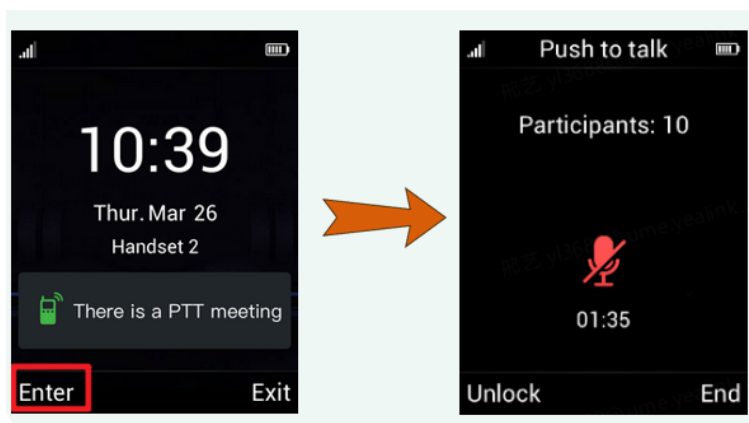

2. For headsets, when another group member initiates a PTT meeting or makes a Push-to-Talk, your headset will join the PTT directly.
3. For DD Phone: press **Enter** to join.

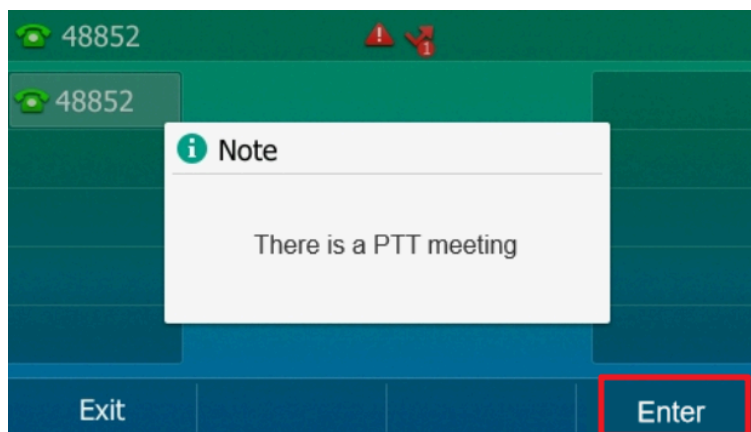

Exiting a PTT Meeting

You can exit a PTT meeting or end the meeting.

 **Note:** You can re-join after exiting the meeting if it has not been finished.

- [Exiting a PTT Meeting on the Handset](#)
- [Exiting a PTT Meeting on the Headset](#)
- [Exiting a PTT Meeting on the DD Phone](#)

Exiting a PTT Meeting on the Handset

Procedure

1. For meeting initiator:
 - a. Press **Unlock** to exit the meeting individually and go back to the PTT operation screen; other participants will not exit the meeting. After this, the initiator can also talk by long pressing the **Mute** key, and other participants also can hear it.
 - b. Press **End** or the On-hook key to end the meeting. Both initiator and participants will exit the meeting and go back to the idle screen.
2. For meeting participants: Press **End** or the On-hook key to exit the meeting and go back to the idle screen. It won't influence other participants.

Exiting a PTT Meeting on the Headset

Procedure

1. For meeting initiator: Press the **Call Control** button to end the meeting for all participants and go back to the idle status.
2. For meeting participants: Press the **Call Control** button to exit the meeting and go back to the idle screen. It won't influence other participants.

Exiting a PTT Meeting on the DD Phone

Procedure

1. For meeting initiator:
 - a. Press **Unlock**, the initiator will exit the meeting individually and go back to the PTT operation screen, other participants will not exit the meeting. After this, the initiator can also talk by long pressing the **PTT** button, and other participants also can hear it.
 - b. Press **End** or On-hook key to end the meeting. Both initiator and participants will exit the meeting and go back to the idle screen.
2. For meeting participants: Press **End** or the On-hook key to exit the meeting and go back to the idle screen. It won't influence other participants.

Push-to-Talk

You can long-press the **Mute/PTT** button and talk in a direct communication channel with other group members.

Procedure

1. For handsets: On the PTT operating screen, long press the **Mute** key to talk.



2. For headsets: Long press the **Mute** button to talk.



3. For DD Phone: On the PTT operating screen, long press the **PTT** key to talk.

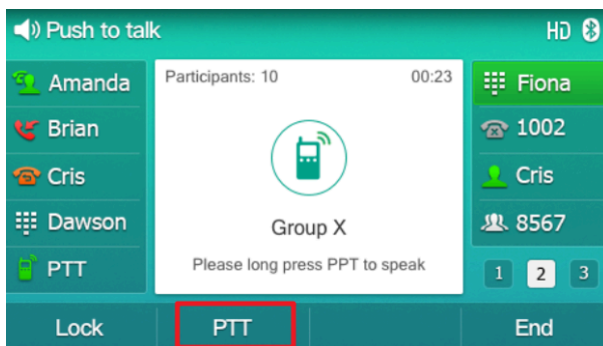

Listening to the Talk in Real Time

You can enter the PTT operation screen and listen to the talk from the same group members in real time.

About this task

You can also enter the operation screen automatically when other members enter the operation screen. Contact your administrator to find out if this feature is available on your phone.

Procedure

1. For handsets: Long press the **Mute** key to enter the PTT operation screen and listen to the talk.
2. For headsets: The headset will enter the PTT status and listen to the talk from others automatically when there is a push-to-talk.
3. For DD Phone: Press the **Push-to-Talk** Line Key directly to enter the PTT operation screen and listen to the talk.

Directory

The phone provides several types of phone directories, which can be customized by your system administrator.

- [Local Directory](#)
- [Shared Directory](#)
- [Blocklist](#)
- [Remote Phone Book](#)

Local Directory

You can store up to 100 contacts in the handset's Local Directory, as well as add, edit and delete a contact.

- [Adding Contacts](#)
- [Viewing Contacts](#)
- [Editing Contacts](#)
- [Deleting Contacts](#)
- [Searching for Contacts](#)

Adding Contacts

When you add a contact to your Local Directory, you can choose how much information you want to enter for your contact. You are required to enter a contact name at least for each new contact.

Procedure

1. Go to **OK > Directory** or **OK > Directory > Local Directory**.
On the CP930W/CP935W/DD phone, select **Directory** or go to **Directory > Local Directory**.
2. Select **Options > New Contact**.
On the W73H/W78H, select **Options > New Entry**.
On the CP930W/DD phone, select **Add**.
On the CP935W, select .
3. Enter the contact's information.
4. Confirm the action.

Viewing Contacts

You can view the local contacts from the Local Directory on your phone.

Procedure

1. Go to **OK > Directory** or **OK > Directory > Local Directory**.

On the CP930W/CP935W/DD phone, select **Directory** or go to **Directory > Local Directory**.

2. Use the navigation keys to look through the contacts.

On the CP935W, you can swipe up and down the screen to look through the contacts.

The contact names are displayed in alphabetical order.

Editing Contacts

You can modify or add more information to your contacts.

Procedure

1. Go to **OK > Directory** or **OK > Directory > Local Directory**.

On the CP930W/CP935W/DD phone, select **Directory** or go to **Directory > Local Directory**.

2. Highlight the desired contact and select **Options > Edit**.

On the CP930W/DD phone, select **Options (Option) > Detail**.

On the CP935W, tap the desired contact to enter the details interface, and then tap .

3. Edit the contact information.
4. Confirm the action.

Deleting Contacts

You can delete one or all contacts from the Local Directory.

- [Deleting a Contact](#)
- [Deleting All Contacts](#)

Deleting a Contact

You can delete any contact from the Local Directory.

Procedure

1. Go to **OK > Directory** or **OK > Directory > Local Directory**.

On the CP930W/CP935W/DD phone, select **Directory** or go to **Directory > Local Directory**.

2. Highlight the desired contact and select **Options (Option) > Delete**.

On the CP935W, select the desired contact to enter the details interface, and then tap **Delete**.

The phone prompts you whether to delete this contact.

3. Confirm the action.

Deleting All Contacts

You can delete all contacts from the Local Directory.

Procedure

1. Go to **OK > Directory** or **OK > Directory > Local Directory**.

On the CP930W/CP935W/DD phone, select **Directory** or go to **Directory > Local Directory**.

2. Highlight the desired contact and select **Options > Delete All**.

On the CP935W, long tap the contact, enter the selected interface, select all contacts and tap  > **Delete**.

The phone prompts you whether to delete all contacts.

3. Confirm the action.

Searching for Contacts

In the Local Directory, you can enter search criteria to find your desired contact quickly.

Procedure

1. Go to **OK > Directory** or **OK > Directory > Local Directory**.

On the CP930W/CP935W/DD phone, select **Directory** or go to **Directory > Local Directory**.

2. Enter your search criteria in the search field.

On the CP930W, enter your search criteria directly by tapping the keypad.

Shared Directory

All handsets that are registered on the same base station can share the contacts with each other. You can store up to 100 contacts in your phone's Shared Directory.

It is not applicable to DD phones.

 **Note:** Check with your system administrator to find out if this feature is available on your phone.

- [Adding Shared Contacts](#)
- [Editing Shared Contacts](#)
- [Deleting a Shared Contact](#)
- [Deleting All Shared Contacts](#)
- [Searching for Shared Directory Contacts](#)
- [Saving a Shared Contact to the Local Directory](#)

Adding Shared Contacts

When you add a contact to your Shared Directory, you can choose how much information you want to enter for your contact. You are required to enter a contact name at least for each new contact.

Procedure

1. Go to **OK > Directory > Shared Directory**.

On the CP930W/CP935W, go to **Directory > Shared Directory**.

2. Select **Options > New Contact**.

On the W73H/W78H, select **Options > New Contact**.

On the CP930W, select **Add**.

On the CP935W, select .

3. Enter the contact's information.
4. Confirm the action.

Editing Shared Contacts

You can modify or add more information to your contacts.

Procedure

1. Go to **OK > Directory > Shared Directory**.

On the CP930W/CP935W, go to **Directory > Shared Directory**.

2. Highlight the desired contact and select **Options > Edit**.

On the CP930W, select **Options > Detail**.

On the CP935W, select the desired contact and select .

3. Edit the contact information.
4. Confirm the action.

Deleting a Shared Contact

You can delete any contact from the Shared Directory.

Procedure

1. Go to **OK > Directory > Shared Directory**.

On the CP930W/CP935W, go to **Directory > Shared Directory**.

2. Highlight a contact and select **Options > Delete**.

On the CP935W, select the desired contact, enter the **Contact Details** interface and select **Delete**.

The phone prompts you whether to delete this contact.

3. Confirm the action.

Deleting All Shared Contacts

You can delete all contacts from the Directory.

Procedure

1. Go to **OK > Directory > Shared Directory**.

On the CP930W/CP935W, go to **Directory > Shared Directory**.

2. Highlight a contact and select **Options > Delete All**.

On the CP935W, long tap the contact, enter the selected interface, select all contacts and tap  **Delete**.

The phone prompts you whether to delete all contacts.

3. Confirm the action.

Searching for Shared Directory Contacts

In the Shared Directory, you can enter search criteria to find your desired contact quickly.

Procedure

1. Go to **OK > Directory > Shared Directory**.

On the CP930W/CP935W, go to **Directory > Shared Directory**.

2. Enter your search criteria in the search field.

On the CP930W, enter your search criteria directly by tapping the keypad.

Saving a Shared Contact to the Local Directory

You can move a shared contact to the Local Directory. The shared contacts added to the Local Directory will not disappear, even after your system administrator disables the Shared Directory feature.

Procedure

1. Go to **OK > Directory > Shared Directory**.

On the CP930W/CP935W, go to **Directory > Shared Directory**.

2. Highlight a contact and select **Options > Add To Local > New Entry**.

On the CP935W, long tap the contact, enter the selected interface, select desired contacts and tap  **> Copy to Local**.

3. Edit the contact information.

It is not applicable to CP935W.

4. Confirm the action.

 **Tip:** You can select **Add To Local > Update Existing** to update the existing contact information.

Blocklist

Incoming calls from the Blocklist are rejected automatically. You can store up to 30 contacts in the blocklist to block unwanted callers.

- [Adding a Blocklist Contact](#)
- [Viewing Blocklist Contacts](#)
- [Editing a Blocklist Contact](#)
- [Deleting Blocklist Contacts](#)

Adding a Blocklist Contact

You can add a blocklist contact on the phone to prevent someone from calling you.

Procedure

1. Go to **OK > Settings > Telephony > Blocklist**.

On the DD phone, go to **Menu > Directory > Blocklist**.

On the CP930W, go to **Menu > Settings > Basic Settings > Blocklist**.

On the CP935W, go to **Directory > Blocklist**.

2. Select **New Entry** or **Options > New Entry**.

On the CP930W/DD phone, select **Add**.

On the CP935W, tap .

3. Enter the contact's information.
4. Confirm the action.

Viewing Blocklist Contacts

You can view the blocklist contacts from the blocklist on your phone.

Procedure

1. Go to **OK > Settings > Telephony > Blocklist**.
 On the DD phone, go to **Menu > Directory > Blocklist**.
 On the CP930W, go to **Menu > Settings > Basic Settings > Blocklist**.
 On the CP935W, go to **Directory > Blocklist**.
2. Use the navigation keys to look through the blocklist contacts.
 On the CP935W, slide the contacts directly to look through.

Editing a Blocklist Contact

You can update your blocklist contacts' information.

Procedure

1. Go to **OK > Settings > Telephony > Blocklist**.
 On the DD phone, go to **Menu > Directory > Blocklist**.
 On the CP930W, go to **Menu > Settings > Basic Settings > Blocklist**.
 On the CP935W, go to **Directory > Blocklist**.
2. Highlight the desired blocklist contact and select **Options > Edit**.
 On the CP930W/DD phone, select **Options (Option) > Detail**.

On the CP935W, select the desired contact to enter the details interface, and then tap .

3. Edit the contact information.
4. Confirm the action.

Deleting Blocklist Contacts

You can delete one or all blocklist contacts. If a contact is removed from the blocklist, you can answer the call from the contact normally.

- [Deleting a Blocklist Contact](#)
- [Deleting All Blocklist Contacts](#)

Deleting a Blocklist Contact

If you want to answer a call from a specific contact, you need to remove it from the blocklist.

Procedure

1. Go to **OK > Settings > Telephony > Blocklist**.
 On the DD phone, go to **Menu > Directory > Blocklist**.
 On the CP930W, go to **Menu > Settings > Basic Settings > Blocklist**.
 On the CP935W, go to **Directory > Blocklist**.
2. Highlight the desired blocklist contact and select **Options > Delete**.
 On the CP935W, select the desired contact to enter the details interface, and then tap **Delete**.
3. Confirm the action.

Deleting All Blocklist Contacts

You can delete all contacts from the Blocklist when you are ready to answer calls from them again.

Procedure

1. Go to **OK > Settings > Telephony > Blocklist**.

On the DD phone, go to **Menu > Directory > Blocklist**.

On the CP930W, go to **Menu > Settings > Basic Settings > Blocklist**.

On the CP935W, go to **Directory > Blocklist**.

2. Highlight the desired blocklist contact and select **Options (Option) > Delete All**.

On the CP935W, long tap the blocklist contact, enter the selected interface, select the desired blocklist contact and tap **⋮ > Delete**.

The phone prompts you whether to delete all contacts.

3. Confirm the action.

Remote Phone Book

If the Remote Phone Book feature has been enabled by your system administrator, you can access your corporate directory directly from your phone.

- [Searching for Remote Phone Book Contacts](#)
- [Viewing Remote Phone Book Contacts](#)
- [Saving a Remote Phone Book Contact to the Local Directory](#)
- [Updating Remote Phone Book](#)

Searching for Remote Phone Book Contacts

In the Remote Phone Book, you can enter search criteria to find your desired contact quickly.

Procedure

1. Select the desired remote phone book.
2. Enter your search criteria in the search field.

On the CP930W, enter your search criteria directly by tapping the keypad.

Viewing Remote Phone Book Contacts

You can view the contact list of the Remote Phone Book on your phone.

Procedure

1. Go to **OK > Directory**.

On the DD phone, go to **Directory > Remote Phone Book**.

On the CP935W, select **Directory**.

2. Select the desired remote phone book.
3. Use the navigation keys to look through the contacts.

On the CP935W, slide the contacts directly to look through.

Saving a Remote Phone Book Contact to the Local Directory

You can save any remote phone book contact to the Local Directory, to conveniently call this contact when you cannot access the Remote Phone Book.

Procedure

1. Go to **OK > Directory**.

On the DD phone, go to **Directory > Remote Phone Book**.

On the CP935W, select **Directory**.

2. Select the desired remote phone book.
3. Highlight the desired contact and select **Options > Add To Local > New Entry**.

On the CP935W, long tap the contact, enter the selected interface, select desired contacts and tap  **> Copy to Local**.

4. Edit the contact information.
5. Confirm the action.

 **Tip:** You can select **Add To Local > Update Existing** to update the existing contact information.

Updating Remote Phone Book

You can manually update the contacts of RemotePhoneBook.

Procedure

1. Go to **OK > Directory**.

On the CP930W/DD Phones/CP935W, select **Directory**.

2. Select the desired remote phone book.
3. Go to **Options > Update**.

On the CP930W/DD Phones, select **Update**.

On the CP935W, tap .

Call History



The call history list includes Missed Calls, Placed Calls and Received Calls, and each list holds 100 entries.

- [Call History Icons](#)
- [Viewing History Records](#)
- [Saving a History Record to Local Directory](#)
- [Saving a History Record to Blocklist](#)
- [Deleting History Records](#)



Call History Icons

The call history icon in the Call History indicates the corresponding call history types.



W59R/W57R/W56H/W53H/W73H/W78H:

Icon	Description
	Received Calls
	Missed Calls
	Placed Calls



CP930W:

Icon	Description
	Received Calls
	Missed Calls
	Placed Calls

DD phone:

Icon	Description
	Received Calls
	Missed Calls
	Placed Calls

CP935W:

Icon	Description
	Received Calls
	Missed Calls
	Placed Calls

Viewing History Records

The history record saves the call information such as the caller's name and number, local line and call duration.

Procedure

1. Press **History**.
2. Select the desired list.
3. Highlight the desired entry and select **Options(Option) > Detail**.

On the CP935W, select the desired entry and tap  to check the details.

Saving a History Record to Local Directory

To identify someone's call the next time, you can save a history record to the Local Directory.

Procedure

1. Press **History**.
2. Select the desired list.
3. Highlight the desired entry and select **Options > Add To Local > New Entry**.

On the DD phone, select **Option > Add to Contacts**.

On the CP935W, select the desired entry and tap  >  > **Add**.

4. Edit the contact information.
5. Confirm the action.



Tip: You can select **Add To Local > Update Existing** to update the existing contact information.

Saving a History Record to Blocklist

You can prevent someone from calling you again by saving a history record to the blocklist.

It is not applicable to DD phones.

Procedure

1. Press **History**.
2. Select the desired list.
3. Highlight the desired entry and select **Options > Add To Blocklist**.

The phone prompts you whether to add it or not.

On the CP935W, tap  > **Blocklist**.

*Select the phone number you want to block and tap **Done**.*

4. Confirm the action.

Deleting History Records

You can delete one or all call records from the call history list.

- [Deleting a Call Record](#)
- [Deleting All Call Records](#)

Deleting a Call Record

You can delete any call record from the call history list.

Procedure

1. Press **History**.
2. Select the desired list.

3. Highlight the desired entry and select **Options** > **Delete**.

On the DD phone, highlight the desired entry and select **Delete**.

On the CP935W, select the desired entry and tap  > **Delete** > **OK**.

The selected entry is deleted successfully.

Deleting All Call Records

You can delete all call records from the call history list.

Procedure

1. Press **History**.
2. Select the desired list.
3. Select **Options (Option)** > **Delete All**.

On the CP935W, long tap a contact to enter the selected interface, select all contacts and tap  > **Delete**.

The phone prompts you whether to delete all records.

4. Confirm the action.

Customizing Your Phone

You can make your phone more personalized by customizing various settings.

- [Turning Handset On](#)
- [Turning Handset Off](#)
- [Changing the Base PIN](#)
- [Changing the Wallpaper](#)
- [Setting the Screen Saver](#)
- [Changing the Brightness](#)
- [Setting the Keypad Light](#)
- [Changing the Language](#)
- [Time & Date](#)
- [Shortcuts](#)
- [Locking Your W73H/W78H/W56H/W53H/W59R/W57R](#)
- [Locking Your DD Phone](#)
- [Locating](#)
- [Renaming the Handset](#)
- [Setting the Eco Mode+](#)
- [Setting the Eco Mode](#)
- [Setting the Repeater Mode](#)
- [Customizing the Soft Keys](#)
- [Phone Mode](#)

Turning Handset On

The W73H/W78H/W56H/W53H/W59R/W57R will be turned on automatically when the battery is inserted into the handset.

About this task

It is only applicable to W73H/W78H/W56H/W53H/W59R/W57R/CP930W/CP935W.

Procedure

Do one of the following:

- Press the On-hook key. The handset screen lights up.
On the CP930W, long press the On-hook key. The mute touch key glows red and then the handset screen lights up.
On the CP935W, long press the Home Key. The mute touch key glows red and then the handset screen lights up.
- Place the handset to the charging cradle.

Turning Handset Off

The handset will be turned off automatically when the battery runs out. You can also turn the handset off manually.

Procedure

Long press the On-hook key when the handset is idle.

On the CP935W, long press the Home Key or tap **More > Basic > Power Off**.

On the CP930W/CP935W, a message prompts whether to power off the device.



Note: You cannot turn the CP930W off when the phone is charging.

Changing the Base PIN

To avoid unauthorized registration or access to some features on the handset, you should keep the base PIN secret. The default base PIN is "0000", you can change it.

Procedure

1. Go to **OK > Settings > System Settings > Change Base PIN**.

On the CP930W, go to **Menu > Settings > Advanced Settings (default PIN: 0000) > Change PIN**.

On the CP935W, go to **More > Advanced (default PIN: 0000) > Change PIN**.

On the DD Phone, go to **Menu > Basic Settings > Change PIN**.

2. Enter the system PIN (default: 0000), and then press **Done**.
3. Enter the new PIN in the **Enter New PIN** and **Re-enter New PIN** field respectively.

On the CP930W/CP935W, enter the new PIN in the **New PWD** and **Confirm PWD** field respectively.

On the DD Phone, enter the Old PIN in the **Old PIN**, the new PIN in the **New PIN** and **Confirm PIN** field respectively.

4. Confirm the action.



Note: We recommend that you set a new random 4-digit PIN that may not be easily guessed.

Changing the Wallpaper

You can change the wallpaper that is displayed on the idle screen.

About this task

It is only applicable to W73H/W78H/W56H/W53H/W59R/W57R/DD phone/CP935W.

Procedure

1. Go to **OK > Settings > Display > Wallpaper**.
On the DD phone, go to **Menu > Basic Settings > Display > Wallpaper**.
On the CP935W, go to **More > Basic > Display > Wallpaper**.
2. Press the navigation keys to select the desired image.
On the CP935W, tap the desired image directly.
3. Confirm the action.

Setting the Screen Saver

The screen saver is designed to protect your phone screen. When the screen saver is enabled, an analog clock will be activated and appear on the phone screen if the handset is idle for approximately 10 seconds.

About this task

It is only applicable to W73H/W78H/W56H/W53H/W59R/W57R.

Procedure

1. Go to **OK > Settings > Display > Screen Saver**.
2. Press **Change** to select the **Screen Saver** check box (the default status is checked).

Changing the Brightness

For W73H/W78H/W56H/W53H/W59R/W57R, the handset backlight in charger or out of charger can be configured independently.

When in charger/out of charger is enabled, the backlight will be turned off after the handset is idle for about 30 minutes when the handset is or is not in the charging cradle. When an incoming call arrives, a key is pressed or the handset status changes, the backlight is automatically turned on.

For CP930W/CP935W, the backlight automatically turns off, when the phone is charging and inactive for a specified time.



Note: When the CP930W/CP935W is not in charging, its backlight will be turned off after the phone is inactive for about 30 seconds.

Procedure

1. Go to **OK > Settings > Display > Display Backlight**.
On the CP930W, go to **Menu > Settings > Basic Settings > Display > Display Backlight**.
On the DD phone, go to **Menu > Basic Settings > Display > Backlight**.
On the CP935W, go to **More > Basic > Display > Backlight**.

2. Select the desired value from the **Active Level** field.

On the CP935W, slide to adjust the backlight brightness in the **Active Level** field.

3. Select the desired value from the **Inactive Level** field (It is only applicable to CP935W).

4. Select the desired value from the **In Charger** or **Out Of Charger** field.

On the CP930W, select the desired value from the **Time in Charger** field.

On the CP935W, select the desired value from the **Backlight Time** field.

5. Confirm the action.

Setting the Keypad Light

You can enable the keypad light to illuminate the keypad keys when any key is pressed.

About this task

It is only applicable to W73H/W78H/W56H/W53H/W59R/W57R.

Procedure

1. Go to **OK > Settings > Display > Keypad LED**.
2. Press **Change** to select the **Keypad LED** check box (the default status is checked).

Changing the Language

Your phone supports several languages that you can choose to use on the phone.

Before you begin

Contact your system administrator to find out exactly which languages are supported on your phone.

Procedure

1. Go to **OK > Settings > Language**.

On the CP930W, go to **Menu > Settings > Basic Settings > Language**.

On the DD phone, go to **Menu > Basic Settings > Language**.

On the CP935W, go to **More > Basic > Language**.

2. Select the desired language.

The phone prompts you whether to change the language.

3. Confirm the action.

The phone language is changed to the selected one.

Time & Date

You can set the time and date manually. The time and date formats are also variable.

- [Setting the Time and Date Manually](#)
- [Changing the Time and Date Format](#)

Setting the Time and Date Manually

If your phone cannot obtain the time and date automatically, you can set it manually.

Procedure

1. Go to **OK > Settings > Date & Time**.

On the CP930W, go to **Menu > Settings > Basic Settings > Time & Date**.

On the DD phone, go to **Menu > Basic Setting > Time&Date > Manual Settings**.

On the CP935W, go to **More > Basic > Time&Date**.

2. Edit the date and time.
3. Confirm the action.

The time and date set on the handset will be changed accordingly.

Changing the Time and Date Format

You can set the phone to display the time in 12-hour or 24-hour format. You can also change the date format, including the options to display the day (D), month (M), and year (Y).

Procedure

1. Go to **OK > Settings > Display > Time Format** or **Date Format**.

On the CP930W, go to **Menu > Settings > Basic Settings > Display > Time Format** or **Date Format**.

On the DD phone, go to **Menu > Basic Setting > Time&Date > Time&Date Format**.

On the CP935W, go to **More > Basic > Display > Time&Date Format**.

2. Select the desired time format or date format.
3. Confirm the action.

Shortcuts

Shortcuts allow you to quickly access the feature without scrolling through the menu when the phone is idle. You can configure six shortcuts on the phone in total.







It is only applicable to W73H/W78H/W56H/W53H/W59R/W57R.

- [Supported Shortcuts](#)
- [Customizing the Shortcuts](#)

Supported Shortcuts

By default, the handset provides a certain access feature for a certain shortcut, you can change it to make your phone more personalized.

The following table lists the default access feature of the desired shortcut, and the available access features for all shortcuts:

Shortcut	Default Access Feature	Available Access Features
Left Softkey	History	History
Right Softkey	Line Status	Missed
 / 	Intercom	Received
 / 	Directory	Redial
 / -	Volume-	Speed Dial
 / +	Volume+	Menu
		Line Status
		Default Line
		Call Forward
		Do Not Disturb
		Intercom
		Directory
		Local Directory
		Remote Directory
		Volume
		Paging
		Shared Directory
		Status
		XML Browser

Customizing the Shortcuts

You can customize the function of the shortcuts to make your handset more personalized.

Procedure

1. Go to **OK > Settings > Shortcut**.
2. Select the desired shortcut and select **Change**.

The feature currently assigned to the selected key is highlighted and followed by a left arrow.

3. Select the desired feature.

Related information

[Supported Shortcuts](#)

Locking Your W73H/W78H/W56H/W53H/W59R/W57R

To prevent accidental use of the handset, the keypad can be locked manually. When the keypad is locked, incoming calls will still ring on your phone, but only the emergency numbers can be dialed out.

- [Locking Handset Keypad](#)
- [Unlocking Your Handset](#)

Locking Handset Keypad

When you temporarily do not use your handset, you can lock it manually.

Procedure

Long press the # key when the handset is idle until the phone prompts you the handset is locked.

The lock icon appears in the status bar.

Unlocking Your Handset

When you need to use the locked handset, you can unlock it manually.

Procedure

Long press the # key when the locked handset is idle until the phone prompts you the handset is unlocked.

The lock icon disappears from the status bar.

Locking Your DD Phone

Phone lock helps you protect your phone from unauthorized use.

- [Setting the Phone Lock](#)
- [Locking Your Phone Manually](#)
- [Unlocking Your Phone](#)
- [Changing Your Phone Unlock PIN](#)

Setting the Phone Lock

You can manually lock the phone or wait a specified time to automatically lock the phone.

About this task

What unauthorized users can do depends on the settings of the phone lock type.

The phone supports the following phone lock types:

- **Menu key:** it prevents unauthorized users from accessing the menu, changing the personal settings for your phone.
- **Function key:** it only allows users to use the keypad for placing a call, answering or rejecting an incoming call and ending a call, and it prevents unauthorized users from other operations.
- **All keys:** it only allows users to use the keypad for dialing an emergency number or authorized numbers that set up by your system administrator, answering or rejecting an incoming call and ending a call, and it prevents unauthorized users from other operations. The phones only support All Keys type of phone lock.



Note: The Volume key always available when you lock the phone.

Procedure

1. Go to **Menu > Basic Settings > Phone Lock**.
2. Enter the desired PIN (default PIN: 123) in the **Unlock PIN** field and confirm the action.
3. Select **Enabled** from the **Lock Enable** field.
4. Select the desired type from the **Lock type** field.
5. Enter the desired interval (0 - 3600 seconds) in the **Auto Lock** field.

If the value is set to 0, the phone will not be automatically locked.

6. Confirm the action.

Locking Your Phone Manually

You can lock the phone manually before the phone is automatically locked.

Before you begin

Make sure that the phone lock is set.

Procedure

Long press # key when the phone is idle.

The lock icon appears on the phone screen.

Unlocking Your Phone

You can use an unlock PIN to unlock the phone.

About this task

If you forget the unlock PIN, you can enter the administrator password to unlock your phone, and then automatically access the PIN change screen.

Procedure

1. Press any locked key, the phone prompts you to enter an unlock PIN.
2. Enter the desired PIN (default: 123) in the **Unlock PIN** field.
3. Confirm the action.

The lock icon disappears from the phone screen.

Changing Your Phone Unlock PIN

The default unlock PIN is "123". For security reasons, you should change the default unlock PIN as soon as possible.

Procedure

1. Go to **Menu > Basic Settings > Change PIN**.
2. Enter your old and new unlock PIN respectively.

The unlock PIN length must be within 15 digits.

3. Confirm the action.





Locating

You can locate a misplaced registered using the base station.

Procedure

Press  on the base station.

All the handset that registered to this base station will ring simultaneously and the screen will display the IP address of the base station.

You can press any key on handset to stop ringing (For CP930W, tap the  , OK key and the **End Call** soft key; For CP935W, tap the ), or press  again on the base station to stop all handsets ringing.

 **Note:** When the handsets are not in the idle status, they will not ring simultaneously.

Renaming the Handset

The handset will be named automatically if successfully registered to the base station. You can personalize the handset name.

Procedure

1. Go to **OK > Settings > Handset Name**.

On the CP930W, go to **Menu > Settings > Basic Settings > Phone Name**.

On the DD phone, go to **Menu > Basic Settings > Phone Name**.

On the CP935W, go to **More > Basic > Phone Name**.

2. Edit the current name in the **Rename/Phone Name** field.
3. Confirm the action.

Setting the Eco Mode+

Eco mode+ turns off the transmission power and the radio waves emitted are virtually zero when the phone is in the standby mode.

About this task

You can enable or disable the eco mode+. If the eco mode+ is enabled, there is no signal interaction between the handset and the base station, and the color of the signal strength indicator on the idle screen will be displayed in green. When a call arrives or a connection occurs, the phone exits the eco mode+ automatically, and the color of the signal strength indicator on the idle screen changes from green to white.

 **Note:** It is only applicable to W73H/W78H/W56H/W53H/W59R/W57R.

Procedure

1. Go to **OK > Settings > System Settings > Eco Mode+**.
2. Press **Change**.
3. Enter the system PIN (default: 0000) and then press **Done**.
The phone prompts whether to reboot the base station.
4. Confirm the action.

The base station reboots to make the change take effect. The change applies to all the handsets registered to the base station. The color of the signal strength indicator on the idle screen will change from white to green.

Setting the Eco Mode

Using the eco mode can greatly reduce the transmission power and signal output when the handset is during a call.

The attenuation range is 20m. When the distance between the base station and the handset is over 20m, the eco mode is disabled automatically. If the eco mode is enabled, the radio coverage of the base station will be reduced.

 **Note:** It is not applicable to DD phones.

Procedure

1. Go to **OK > Settings > System Settings > Eco Mode**.
On the CP930W, go to **Menu > Settings > Basic Settings > Eco Mode**.
On the CP935W, go to **More > Basic > Eco Mode**.
2. Select **Change**.

Setting the Repeater Mode

Using the repeater mode can extend the radio coverage of the base station. This feature gives you more mobility in large dwelling.

If the repeater mode is enabled, and a repeater is registered to this base station, the handset registered to the base station can be used either within the range of the base station or the repeater. It provides users with greater freedom of mobility.

For more information on how to use DECT repeater with the base station, refer to [Yealink DECT Repeater User Guide](#).

Before you begin

Repeater mode and eco mode+ features cannot be used at the same time.

Procedure

1. Go to **OK > Settings > System Settings > Repeater Mode**.
On the CP930W, go to **Menu > Settings > Advanced Settings (default PIN: 0000) > Repeater Mode**.
On the CP935W, go to **More > Advanced (default PIN: 0000) > Repeater Mode**.
2. Select a desired repeater and press **OK**.
The handset prompts whether to reboot this base station.
3. Confirm the action.
The base station reboots to make the change take effect. The change is applied to all the handset registered to the base station.

Related tasks

[Setting the Eco Mode+](#)

Customizing the Soft Keys

You can customize the function of the soft keys displayed on the bottom of the idle screen. The soft keys are typically used to access frequently used functions, and to create menu shortcuts to access frequently used phone settings.

About this task

It is only applicable to the CP930W/DD phone.

Procedure

1. Go to **Menu > Settings > Advanced Settings (default PIN: 0000) > Softkey Label**.
2. Select the desired soft key.
3. Select the desired key type from the **Type** field.
4. Confirm the action.



Note: If you replace another key of the **Menu** soft key on CP930W, you can access the phone settings by pressing the **OK** key. For DD phone, we recommend that you keep a **Menu** soft key; otherwise, you may not access the phone settings.

Phone Mode

You can freely switch between Wi-Fi and DECT modes according to actual usage scenarios.



Note: It is only applicable to CP935W.

Procedure

1. Tap **More > Basic > Phone Mode**.
2. Select the desired mode.
3. Confirm the action.

Audio Settings

You can change the basic audio settings on your phone.

- [Silent Mode](#)
- [Adjusting the Volume](#)
- [Setting the Ring Tone](#)
- [Silent Charging](#)
- [Setting the Advisory Tone](#)
- [Setting the Vibrator](#)
- [Disabling the Noise Cancellation](#)

Silent Mode

You can enable the silent mode if you do not want to be disturbed. The handset will not ring when receiving an incoming call, but it will still display the incoming call information.

It is only applicable to W73H/W78H/W56H/W53H/W59R/W57R.

- [Switching on Silent Mode](#)
- [Switching off Silent Mode](#)

Switching on Silent Mode

You can silence an incoming call by switching on silence mode to stop your phone from ringing.

Procedure

Long press the * key until the phone prompts “All Ring Tones Off”.

The silent icon  appears in the status bar.

Switching off Silent Mode

If you want to resume the incoming ring, you can switch off silent mode.

Procedure

Long press the * key until the phone prompts “All Ring Tones On”.

The silent icon  disappears from the status bar.

Adjusting the Volume

You can adjust the volume of the ringer, media, and audio during a call.

Procedure

Do one of the following:

- Press the Volume key.
- Press the left or right navigation key when the handset is idle.
- Go to **OK > Settings > Audio > Ring Tones > Volume** and press the left or right navigation key.

On the CP930W/CP935W, press the Volume touch key.

On the DD phone, press the Volume key .

Setting the Ring Tone

Ring tones are used to indicate the incoming calls.

- [Setting the Ring Tone for the Internal Calls](#)
- [Setting the Ring Tone for the External Calls](#)

Setting the Ring Tone for the Internal Calls

You can select a unique ring tone for the internal calls, so that you can identify callers when the phone rings.

Procedure

1. Go to **OK > Settings > Audio > Ring Tones > Melodies**.

On the CP930W, go to **Menu > Settings > Basic Settings > Sound > Ring Tones > Intercom Call**.

On the CP935W, go to **More > Basic > Sound > Ring Tones > Intercom Call**.

2. Select the desired ring tone.

The ring tone is played automatically.

3. Confirm the action.

Setting the Ring Tone for the External Calls

You can select a unique ring tone for the external calls so that you can identify callers when the phone rings.

Procedure

1. Go to **OK > Settings > Audio > Ring Tones > Melodies.**

On the CP930W, go to **Menu > Settings > Basic Settings > Sound > Ring Tones.**

On the CP935W, go to **More > Basic > Sound > Ring Tones > Common.**

On the DD phone, go to **Menu > Basic Settings > Sound > Ring Tones > Common.**

2. Select the desired ring tone for a specific line.

The ring tone is played automatically.

3. Confirm the action.

Silent Charging

You can enter silent mode when the handset is charging. When you exit charging, return to the volume before charging. It is not applicable to DD phones/CP935W.

Procedure

1. Go to **OK > Settings > Audio.**

On the CP930W, go to **Menu > Settings > Basic Settings > Sound.**

2. Press **Change** to select the **Silent Charging** check box.

Setting the Advisory Tone

Advisory tones are the acoustic signals of your handset, which inform you of different actions and states. It is not applicable to DD phones.

About this task

You can configure the following advisory tones independently:

- **Keypad Tone:** plays when you press any key on the keypad. It is not applicable to CP935W.
- **Key Tone:** plays when you use the dialpad. It is only applicable to CP935W.
- **Touch Tone:** plays when you tap the keys (except the touch keypad). It is only applicable to CP930W/CP935W.
- **Confirmation:** plays when a setting is changed or the handset is placed in the charger cradle. It is not applicable to CP935W.
- **Low Battery:** plays when the battery's remaining capacity is low and the handset needs charging.



Note: If the silent mode is activated, the advisory tones will not play, but you can still see the alert of low battery on the phone screen.

Procedure

1. Go to **OK > Settings > Audio > Advisory Tones.**

On the CP930W, go to **Menu > Settings > Basic Settings > Sound > Advisory Tones.**

On the CP935W, go to **More > Basic > Sound > Advisory Tone.**

2. Select the desired value from the **Keypad Tone** field.

On the CP935W, select the desired value from the **Key Tone** field.

3. On the CP930W/CP935W, select the desired value from the **Touch Tone** field.

4. Select the desired value from the **Confirmation** field.
5. Select the desired value from the **Low Battery** field.
6. Confirm the action.

Setting the Vibrator

By default, the phone simultaneously vibrates and rings when receiving an incoming call.

About this task

It is only applicable to W57R/W59R.

The following vibration settings are available for the incoming call:

- **Vibrate and Ring:** The handset will simultaneously ring and vibrate.
- **Vibrate:** The handset will vibrate only.
- **Vibrate then Ring:** The handset will vibrate four times and then start ringing.
- **Off**



Note: If the silent mode is activated, the handset will not vibrate and ring.

Procedure

1. Go to **OK > Settings > Audio > Vibrate**.
2. Select the desired method.

Disabling the Noise Cancellation

Noise cancellation helps improve intelligibility of speech in noisy environments. You can disable it.

About this task

It is only applicable to W57R/W59R/W73H.

Procedure

1. Go to **OK > Settings > Audio > Noise Cancellation**.
2. Disable the noise cancellation.
3. Confirm the action.

Connecting a Mobile Phone to your CP930W/CP935W via Bluetooth

Bluetooth enables low-bandwidth wireless connections within a range of 10 meters (32 feet). The best performance is in the range of 1 to 2 meters (3 to 6 feet).

You can pair and connect the Bluetooth-enabled mobile phone with your phone. After connection, you can do the following:

- Make and receive mobile calls on the phone
- Use the phone as a Bluetooth speaker for your mobile phone to play music.
- Merge the calls on your phones, the PC and connected mobile phone into a hybrid UC conference

It is only applicable to CP930W/CP935W.

- [Activating the Bluetooth Mode](#)
- [Pairing and Connecting the Bluetooth-enabled Mobile Phone](#)
- [Enabling the Phone Audio](#)
- [Enabling the Phone Media](#)
- [Handling a Mobile Phone Call on the Phone](#)
- [Editing Device Name of Your Phone](#)
- [Making the Phone Discoverable](#)
- [Deleting the Paired Bluetooth Device](#)
- [Disconnecting the Bluetooth Device](#)
- [Deactivating the Bluetooth Mode](#)

Related tasks

[Creating a Hybrid UC Meeting with Mobile Phone and PC](#)

Activating the Bluetooth Mode

You should activate the Bluetooth mode first when you need to connect the Bluetooth device to your phone.

Procedure

1. Tap  or go to **Menu > Settings > Basic Settings > Bluetooth**.

On the CP935W, tap  or go to **More > Basic > Bluetooth**.

2. Select **On** from the **Bluetooth** field.

On the CP935W, turn on the Bluetooth.

3. Confirm the action.

Pairing and Connecting the Bluetooth-enabled Mobile Phone

The phone cannot scan the Bluetooth devices, so you have to pair and connect the phone from your Bluetooth-enabled mobile phone.

Before you begin

Make sure you have activated the Bluetooth mode and made the phone discoverable.

Procedure

1. Scan and pair the phone from the Bluetooth-enabled mobile phone (the default device name of your phone is "Yealink-CP930W"/"Yealink-CP935W").
2. Select **OK** when the phone prompts the connection passkey.

Related tasks

[Activating the Bluetooth Mode](#)

[Making the Phone Discoverable](#)

Enabling the Phone Audio

When you enable the phone audio, the phone can act as a speaker and microphone for your connected mobile phone.

The call is made through your mobile phone, but the audio is present on the phone and the call is also controlled by the phone.

Procedure

1. Select  > **Paired Bluetooth Device** or go to **Menu > Settings > Basic Settings > Bluetooth > Paired Bluetooth Device**.

On the CP935W, tap  > **Paired Devices** or go to **More > Basic > Bluetooth > Paired Devices**.

2. Select **Options > Detail > Channel Control**.

On the CP935W, tap .

3. Select **Enabled** from the **Phone Audio** field.

On the CP935W, turn on the **Phone Audio**.

4. Confirm the action.

Enabling the Phone Media

You can enable the media audio feature to use the phone as a Bluetooth speaker for your mobile phone/PC to play music.

Procedure

1. Select  > **Paired Bluetooth Device** or go to **Menu > Settings > Basic Settings > Bluetooth > Paired Bluetooth Device**.

On the CP935W, tap  > **Paired Devices** or go to **More > Basic > Bluetooth > Paired Devices**.

2. Select **Options > Detail > Channel Control**.

On the CP935W, tap .

3. Select **Enabled** from the **Media Audio** field.

On the CP935W, turn on the **Media Audio**.

4. Confirm the action.

 **Note:** When your device first connects to CP930W, you will be asked whether to open the media channel after connecting successfully.

Handling a Mobile Phone Call on the Phone



You can handle a mobile phone call on your phone, the phone acts as a speaker and microphone for your mobile phone.

Before you begin

1. Make sure that the Bluetooth-enabled mobile phone is paired and connected to your phone.
2. You have enabled the phone audio.

Procedure

Do the following on the phone:

- Place a call. Tap , and then tap **Switch** to switch to the Bluetooth channel. Place a call or multiple calls to the mobile contact.
On the CP935W, tap  in the upper right corner to switch to the Bluetooth channel first and then tap .
- Answer a call. An incoming call to your mobile phone is also shown on the phone, you can answer the call on the phone.
- During the call, you can hold/resume, mute/unmute or end the call on the phone.

Editing Device Name of Your Phone

You can edit the device name of your phone for easily recognizable.

Before you begin

Make sure that the Bluetooth mode is activated.

Procedure

1. Select  > **Edit My Device Information** or go to **Menu** > **Settings** > **Basic Settings** > **Bluetooth** > **Edit My Device Information**.

On the CP935W, tap  > **Edit My Device Information** or go to **More** > **Basic** > **Bluetooth** > **Edit My Device Information**.

The phone screen displays the device name.

2. Enter the desired name in the **Device Name** field.
3. Confirm the action.

Related tasks

[Activating the Bluetooth Mode](#)

Making the Phone Discoverable

If you make your phone discoverable to other Bluetooth devices, other Bluetooth devices can scan and find your IP phone.

Before you begin

Make sure that the Bluetooth mode is activated.

Procedure

1. Select  > **Edit My Device Information** or go to **Menu** > **Settings** > **Basic Settings** > **Bluetooth** > **Edit My Device Information**.

On the CP935W, tap  > **Edit My Device Information** or go to **More** > **Basic** > **Bluetooth** > **Edit My Device Information**.

2. Select **On** from the **Open Discover** field.
On the CP935W, turn on the **Open Discover**.
3. Confirm the action.

Related tasks[Activating the Bluetooth Mode](#)

Deleting the Paired Bluetooth Device

You can delete the Bluetooth device paired from your phone, the next time you activate the Bluetooth mode, the phone will not automatically connect to this device.

Procedure

1. Select  > **Paired Bluetooth Device** or go to **Menu > Settings > Basic Settings > Bluetooth > Paired Bluetooth Device**.

On the CP935W, tap  > **Paired Bluetooth Device** or go to **More > Basic > Bluetooth > Paired Bluetooth Device**.

2. Select **Options > Delete**.

On the CP935W, select the desired device and tap  > **Unpair**.

The phone prompts you whether to delete the device.

3. Confirm the action.

Disconnecting the Bluetooth Device

You can disconnect your Bluetooth device from your phone. When you disconnect a Bluetooth device, it remains paired and you can reconnect it to your phone.

Procedure

1. Select  > **Paired Bluetooth Device** or go to **Menu > Settings > Basic Settings > Bluetooth > Paired Bluetooth Device**.

On the CP935W, tap  > **Paired Bluetooth Device** or go to **More > Basic > Bluetooth > Paired Bluetooth Device**.

2. Highlight the connected Bluetooth device and select **Disconnect**.

On the CP935W, tap the device you want to disconnect and the phone prompts you whether to disconnect the device, and then tap **OK** to confirm the action.

Deactivating the Bluetooth Mode

After you deactivate the Bluetooth mode, the Bluetooth device will disconnect from your phone, but it remains paired and you can reconnect it to your phone.

Procedure

1. Tap  or go to **Menu > Settings > Basic Settings > Bluetooth**.

On the CP935W, tap  or go to **More > Basic > Bluetooth**.

2. Select **Off** from the **Bluetooth** field.

On the CP935W, turn off the button in the **Bluetooth** field.

3. Confirm the action.

W59R/W57R/W78H Bluetooth

The W59R/W57R/W78H handset can be used with a Bluetooth headset. By default, the Bluetooth feature is disabled. To be able to use Bluetooth, it must be enabled.

- [Enabling/Disabling the Bluetooth](#)
- [Searching and Pairing with a Bluetooth Headset](#)
- [Managing Paired Headsets](#)
- [Editing Device Name of Your Handset](#)

Enabling/Disabling the Bluetooth

Procedure

1. Go to **OK > Settings > Bluetooth**.
2. Select **Enabled/Disabled** from the **Bluetooth** field.
3. Confirm the action.

Searching and Pairing with a Bluetooth Headset

Before you begin

Make sure that the Bluetooth mode is activated.

Procedure

1. Go to **OK > Settings > Bluetooth**.
2. Select **Scan Devices**.
The search result list displays up to 20 Bluetooth devices.
3. Put the Bluetooth headset into pairing mode.
For more information, please refer to the headset's user guide.
4. If the W59R/W57R/W78H has detected more than one headset, select the headset you want from the list and press **Pair**.
When pairing is successful, you will see the message "Connect Success".

Managing Paired Headsets

Procedure

1. Go to **OK > Settings > Bluetooth**.
2. Select **Paired Devices**.

3. Select the handset and press **Discon.** or **Connect** to unpair or connect to the device.
4. Select **Options** and you can do the following:
 - Select **Delete** to delete the selected handset from the list.
 - Select **Delete All** to delete all handsets from the list.
 - Select **Info** to view the handset name and Bluetooth MAC or change the name of the handset.

Editing Device Name of Your Handset

You can edit the name of the W59R/W57R/W78H, so that it can be easily recognized.

Before you begin

Make sure that Bluetooth is enabled.

Procedure

1. Go to **OK > Settings > Bluetooth > My Devices.**

The phone screen displays the device name.

2. Enter the desired name in the **Device Name** field.
3. Confirm the action.

Using Your CP930W/CP935W with PC

When connected to the PC, the phone acts as a speaker and microphone during calls.

From your phone, you can do the following:

- Manage the audio from calls or media played on your PC.
- Merge phone calls, the PC and connected mobile phone into a hybrid UC conference.
- Answer calls from the softphone.



Note: You can install a softphone (for example, Yealink VC Desktop) on PC to make calls.

It is only applicable to CP930W/CP935W.

- [Connecting the PC to the Phone](#)
- [Setting the Phone as PC Audio Device](#)
- [Placing Calls via PC](#)
- [Holding/Resuming the PC Audio](#)
- [Muting/Unmuting the Microphone](#)

Related tasks

[Creating a Hybrid UC Meeting with Mobile Phone and PC](#)

Connecting the PC to the Phone

You can connect the PC to the phone to play the PC audio.

Procedure

On the CP930W: Connect the phone to a PC using a micro USB cable.

On the CP935W: Connect the phone to a PC using a Type C cable.

- When your phone is idle, the phone screen is shown below:

CP930W:



CP935W:



- When there is a call or conference call on your phone, the original call or conference call is placed on hold.
- When you are placing a call, the dialing is canceled.



Note: When you connect the PC to the phone, the phone is also charged at the same time. It is not applicable to CP935W.

Setting the Phone as PC Audio Device

By default, the PC automatically selects the connected phone as the audio device. If not, you may have to set the phone as a PC audio device via softphone or PC.

- [Setting the Phone as PC Audio Device via Softphone](#)
- [Setting the Phone as PC Audio Device via PC](#)

Setting the Phone as PC Audio Device via Softphone

When your PC is connected to the phone, you can set the phone as a PC audio input and an output device via the softphone, for example, Yealink VC Desktop.

Procedure

1. In the top-left corner of the window, click the avatar icon to enter the settings window.
2. Click **Device**.
3. Select your phone from the **Speaker** drop-down menu.
4. Select your phone from the **Microphone** drop-down menu.
5. Optional: Click **Test** to test the microphone or the speaker.

Setting the Phone as PC Audio Device via PC

When your PC is connected to the phone, you can set the phone as the PC default audio device via PC.

Procedure

1. Click **Start > Control Panel > Sound**.
2. Click **Echo Cancelling Speakerphone (Yealink CP930W Speakerphone)** and click **Set as Default Device**.

On the CP935W, click **Echo Cancelling Speakerphone(Yealink CP935W)** and click **Set as Default Device**.

3. Click **Microphone (Yealink CP930W Speakerphone)** and click **Set as Default Device**.

On the CP935W, click **Microphone (Yealink CP935W)** and click **Set as Default Device**.

4. Confirm the action.

Placing Calls via PC

If you have installed a softphone (for example, Yealink VC Desktop) on PC, you can place calls and the phone acts as a microphone and a speaker.

Before you begin

Make sure you have set your phone as the PC audio device.

Procedure

1. Make the call (or answer an incoming call) using the installed softphone on PC.

The microphone is automatically activated on your phone.

2. End the call on the softphone.

The phone now only functions as a speaker for the PC.

Holding/Resuming the PC Audio

When you place the PC audio on hold, you cannot hear any audio on your phone.

Procedure

1. Select **Hold** to hold the call.
2. Select **Resume** to resume the call.

Muting/Unmuting the Microphone

When you mute the microphone during a call, the other party cannot hear you but you can hear other parties.

Procedure

1. Tap the Mute touch key.

The mute touch key LED indicators glow red.

2. Tap the Mute touch key again to unmute the microphone.

Maintaining Your Phone

When your phone cannot operate properly, you need to investigate or troubleshoot issues along with other tasks that your administrator may ask you to perform.

- [Investigating Warnings](#)
- [Restarting the Base Station](#)
- [Resetting the Base Station](#)
- [Restarting the Handset](#)
- [Resetting the Handset](#)
- [Triggering the Auto Provisioning](#)

Investigating Warnings

When the default password is used on the phone, you can view the warning details about the issue from Status screen.

Procedure

Go to **OK > Status > Base**.

On the CP930W/DD phone, go to **Menu > Status > Base(Base Status)**.

On the CP935W, go to **More > Status > Base Status**.

*The warning detail is displayed in the **Warning (Warnings)** field.*

Restarting the Base Station

The improper operation may cause malfunction. If a malfunction occurs, your system administrator may ask you to restart the base station to refresh the settings.

Procedure

1. Go to **OK > Settings > System Settings > Base Restart**.

On the CP930W, go to **Menu > Settings > Advanced Settings (default PIN: 0000) > Reboot Config > Base Reboot**.

On the DD Phone, go to **Menu > Advanced Settings (default PIN: 0000) > Reboot Config > Base Reboot**.

On the CP935W, go to **More > Advanced (default PIN: 0000) > Reboot > Base Reboot**.

2. Enter the system PIN (default: 0000), and then press **Done**.

On the CP935W, tap **Reboot**.

3. Confirm the action.

Results

After the above steps, the registration LED and network status LED on the base station go out simultaneously. After a period of time, the LED indicators will glow green again when the base station restarts successfully.

Resetting the Base Station

Your system administrator may ask you to reset your phone to factory after you have tried all troubleshooting suggestions but still do not solve the problem.

Except the handset registrations, the phone will reset all settings to the factory defaults after the resetting. Check with your system administrator if the personalized settings are kept before resetting your phone to factory.

Procedure

1. Go to **OK > Settings > System Settings > Base Reset**.

On the CP930W, go to **Menu > Settings > Advanced Settings (default PIN: 0000) > Reboot Config > Reset Base Settings**.

On the DD Phone, go to **Menu > Advanced Settings (default PIN: 0000) > Reset Config > Base Reset**.

On the CP935W, go to **More > Advanced (default PIN: 0000) > Reset > Base Reset**.

2. Enter the system PIN (default: 0000), and then press **Done**.

On the CP935W, tap **Base Reset** directly.

3. Select **Reset to factory**.

A message prompts whether to reset the base.

4. Confirm the action.

Results

All individual settings of the base station will be reset to factory defaults. The power LED indicator and network LED indicator on the base station slowly flash in sequence during the resetting. LEDs on the base station glow green after startup.

- ⚠ **Important:** Base station reset may take a few minutes. Do not power off until the base station starts up successfully.

Restarting the Handset

You can restart the handset according to your needs.

About this task



Note: It is only applicable to CP930W/CP935W.

Procedure

1. On the CP930W, go to **Menu > Settings > Advanced Settings (default PIN: 0000) > Reboot Config > Handset Reboot**.

On the CP935W, go to **More > Advanced (default PIN: 0000) > Reboot > Handset Reboot**.

2. Tap **OK**.

On the CP935W, tap **Reboot**.

A message prompts whether to reboot the handset.

Resetting the Handset

You can reset individual settings that you have configured on the handset.

Except the settings of directory, call history, voice mail, and the handset registration, the handset will reset all customized settings to factory after the resetting.

Procedure

1. Go to **OK > Settings > System Settings > Handset Reset**.

On the CP930W, go to **Menu > Settings > Advanced Settings (default PIN: 0000) > Handset Reset**.

On the DD phone, go to **Menu > Advanced Settings (default PIN: 0000) > Reset Config > Handset Reset**.

On the CP935W, go to **More > Advanced (default PIN: 0000) > Reset > Handset Reset**.

The phone prompts you whether to reset the handset.

2. Confirm the action.

Triggering the Auto Provisioning

Your system administrator may ask you to update your phone configurations. You can trigger the auto provisioning using the wizard.

Procedure

1. Go to **OK > Settings > System Settings > Auto Provision**.

On the CP930W, go to **Menu > Settings > Advanced Settings (default PIN: 0000) > Auto Provision**.

On the DD Phone, go to **Menu > Advanced Settings (default PIN: 0000) > Auto Provision**.

On the CP935W, go to **More > Advanced (default PIN: 0000) > Auto Provision**.

2. Enter the system PIN (default: 0000), press **Done**.

3. Enter the user name, select **OK**.

4. Enter the password, select **OK**.

The phone prompts whether to update immediately.

5. Confirm the action.

On the CP935W, enter the user name and password directly, and then tap  to save and confirm the action.

Appendix

- [Appendix A- Menu Structure](#)
- [Appendix B - Input Modes and Characters](#)

Appendix A- Menu Structure

W73H/W56H/W53H/W59R/W57R:

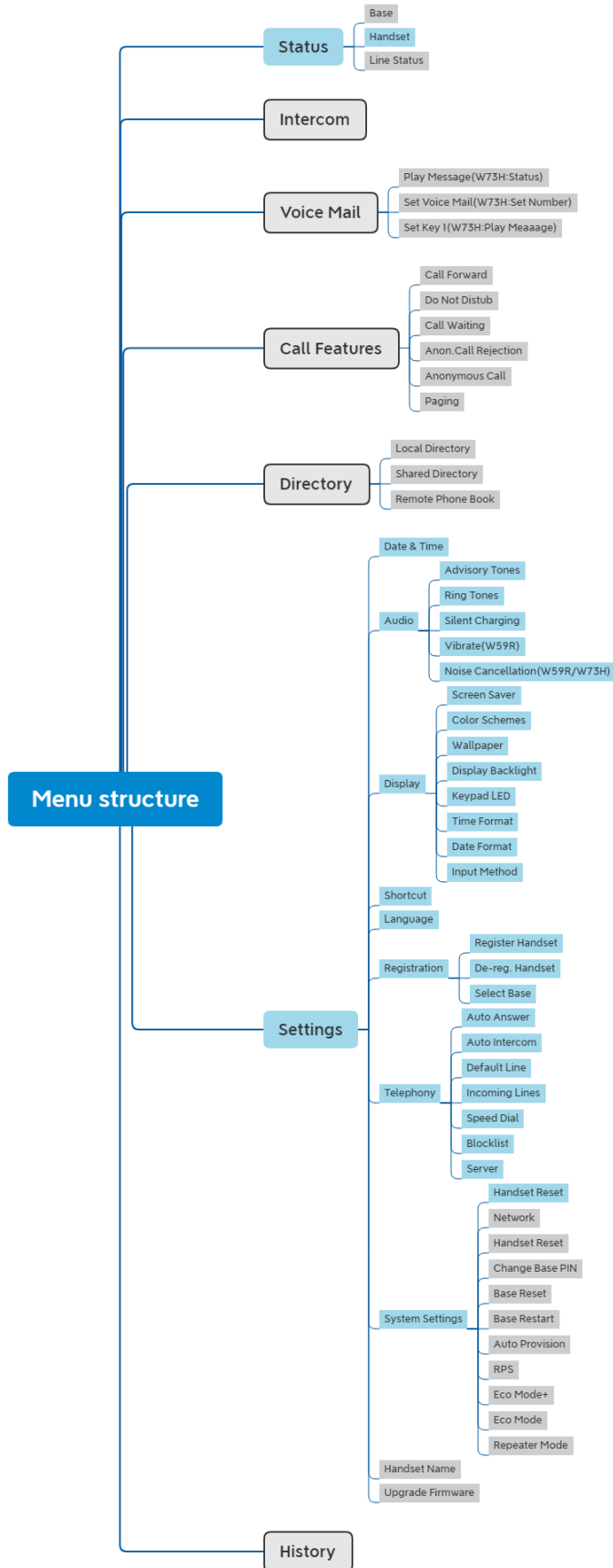



Note: The menus in the gray box are not available when the handset is not registered to a base station.

W78H:

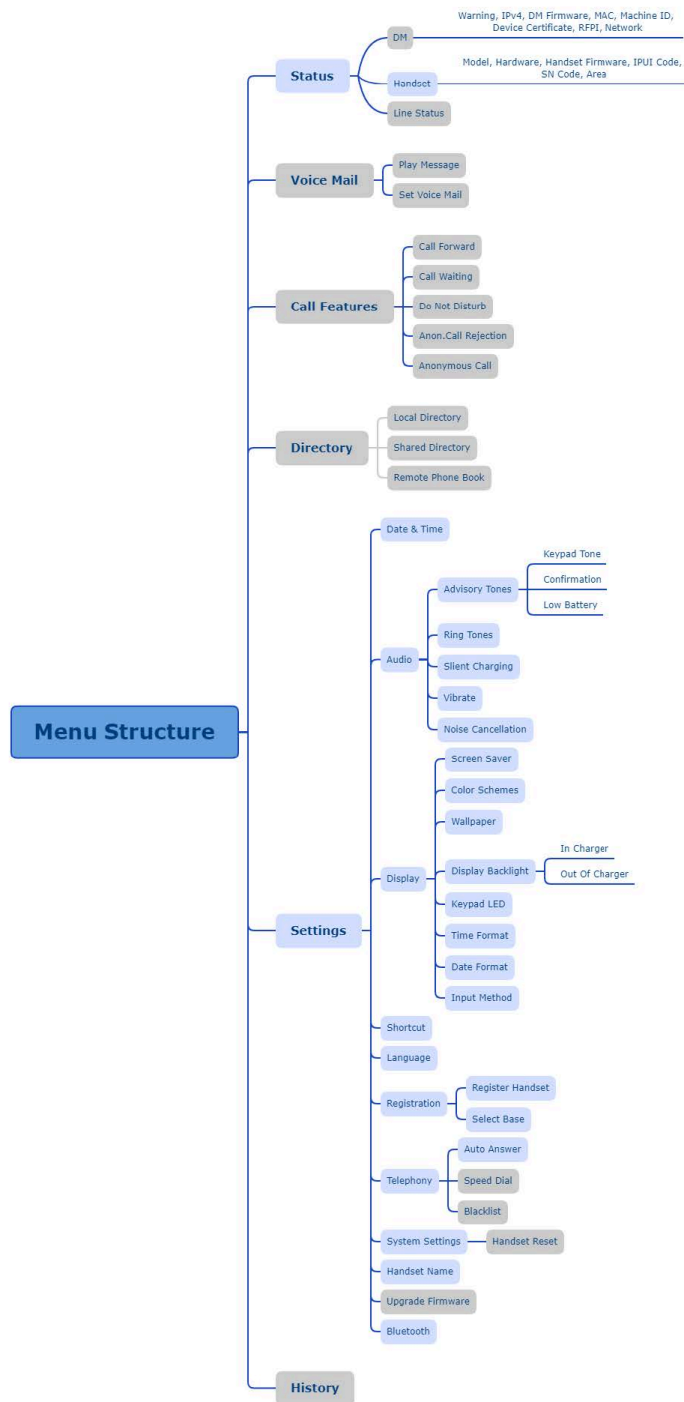

Note: The menus in the gray box are not available when the handset is not registered to a base station.

CP930W:

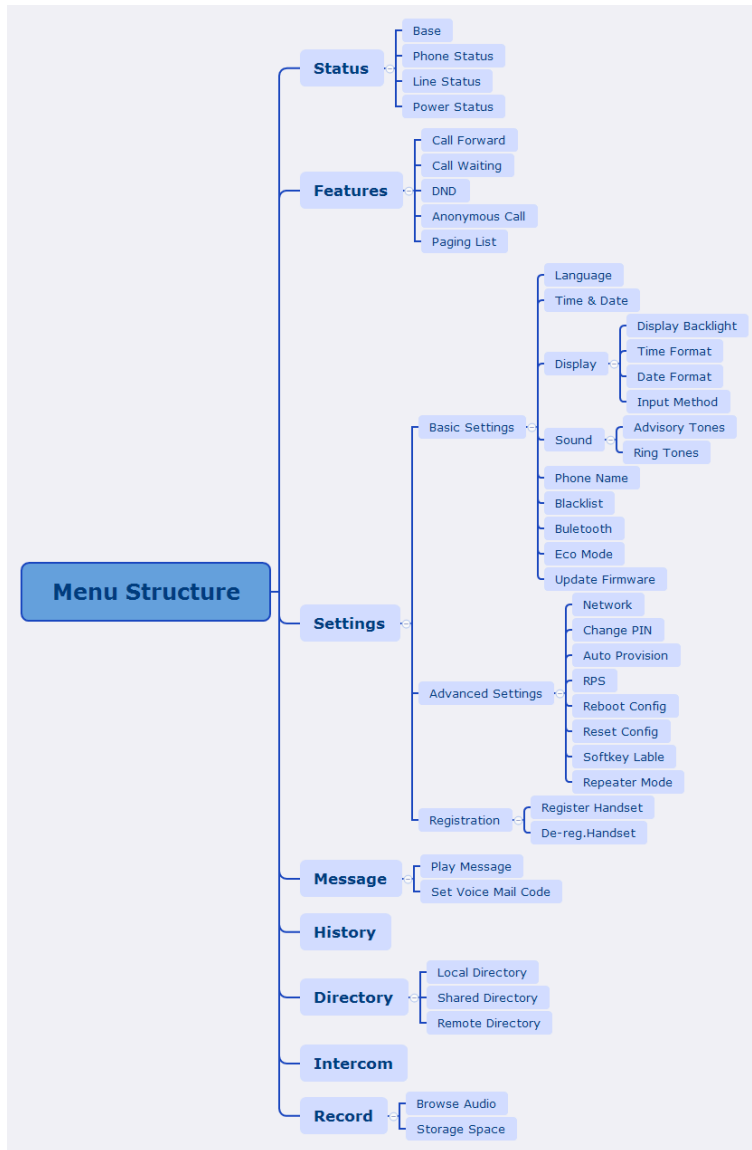

DD phone:

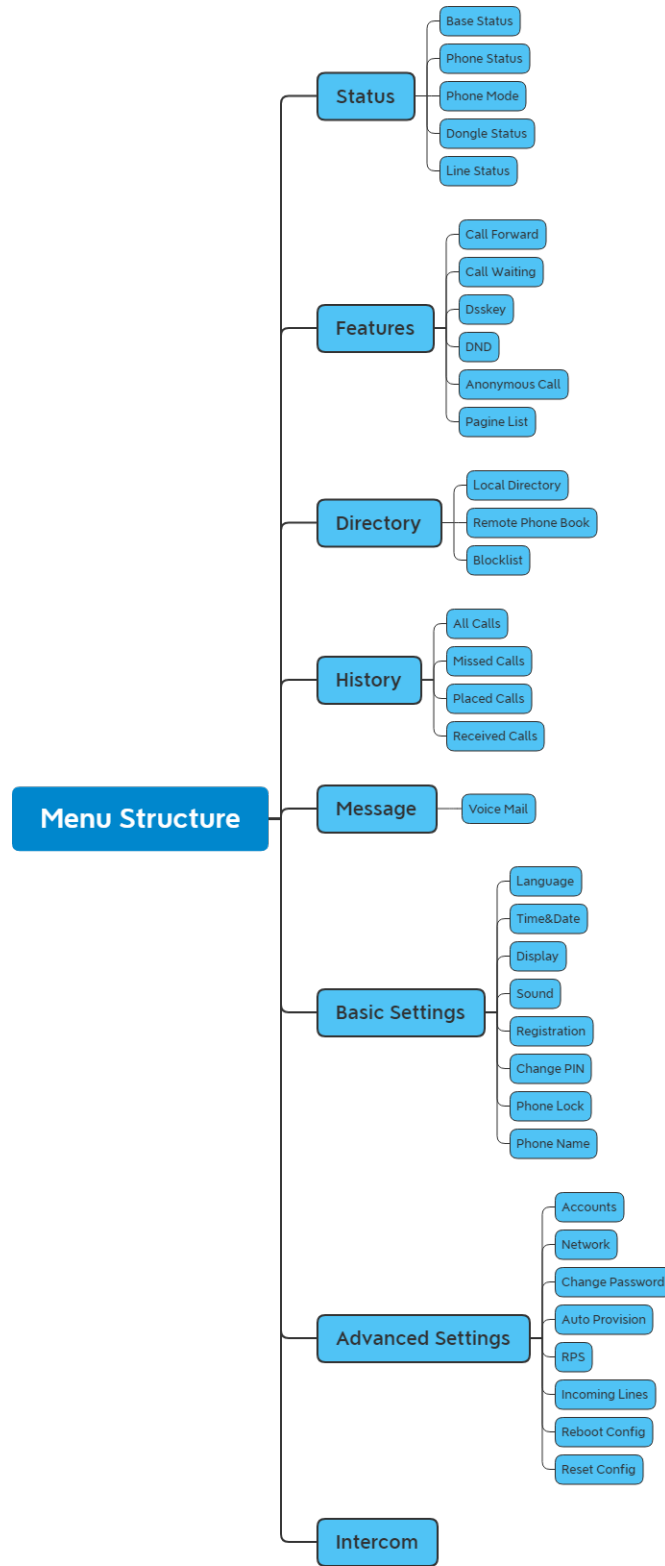

CP935W:

